

Variosuc 0624



EN

Installation and Operating Instructions

CE 0124

9000-606-40/30



 DÜRR
DENTAL

2011/02

Content



Important Information

1. General	4
1.1 Note on Conformity	4
1.2 General Notes	4
1.3 General Safety Notes	4
1.4 Notes on medical products	5
1.5 Electrical safety instructions	5
1.6 Warnings and Symbols	5
2. Product Information	6
2.1 Correct Usage	6
2.2 Incorrect Usage	6
3. Model Overview	6
4. Delivery Contents	6
4.1 Disposable materials	6
5. Technical Data	7
5.1 Ambient conditions	7
6. Functional layout	8
7. Functional Description	9



Mounting

8. Packing protection	10
9. Set-up	10
10. Electrical Connection	10
11. Final procedures	10



Use

12. Operating the Variosuc	11
12.1 Switching the Variosuc On and Off	11
12.2 Suction of fluids	11
12.3 Emptying the fluid container	11
12.4 Display Panel (depending on model)	11
13. Disinfection and Cleaning	12
13.1 For reasons of hygiene and perfect function, after every patient treatment	12
13.2 Before lunch break and at the end of the day	13
13.3 Weekly and before longer surgery holidays	13
14. Changing the filter	15
14.1 Filter change - 1 x week	15
14.2 Exhaust air germ filter	15
15. Electrical Connection	16



Disposal

16. Appliance disposal	17
-------------------------------	----



Important Information

1. General



The following information concerning the Variosuc **is** supplementary to the Installation and Operating Instructions supplied.

The Installation and Operating Instructions supplied **MUST ALSO** be observed. The Installation and Operating Instructions include important information concerning Safety Notes, Technical Data, Set-up, Electrical Connection, Disinfection, Cleaning, etc.

1.1 Note on Conformity

This product has undergone testing in accordance with the guidelines laid down under 93/42/EWG of the European Union for Conformity and has been found to satisfy all the necessary requirements of these regulations.

1.2 General Notes

- These Installation and Operating Instructions form an integral part of the unit. They must be kept close to the unit at all times. Precise observance of these instructions is a precondition for use of the unit for the intended purpose and for its correct operation. New personnel must be made aware of the contents, and they should be passed on to future operating staff.
- Safety for the operator as well as trouble-free operation of the unit are only ensured if use is made of original equipment parts. In addition, only those accessories may be used which are specifically mentioned in the Installation and Operating Instructions or have been authorised by Dürr Dental. If other accessories are used with this appliance, Dürr Dental cannot guarantee safe operation or proper functioning. No liability on the part of the manufacturer will be accepted in the case that damage arises through the use of non-approved accessories.
- Dürr Dental are only responsible for the equipment with regard to safety, reliability and proper functioning where assembly, resetting, changes or modifications, extensions and repairs have been carried out by Dürr Dental or an agency authorized by Dürr Dental

and if the equipment is used in conformity with the Installation and Operating Instructions.

- These Installation and Operating Instructions conform to the relevant version of the equipment and the underlying safety standards valid at the time of going to press. All circuits, processes, names, software and appliances quoted are protected under industrial property rights.
- Any reprinting of the technical documentation, in whole or in part, is subject to prior approval of Dürr Dental being given in writing.

1.3 General Safety Notes

This appliance has been so designed and developed by Dürr Dental that under correct usage that there can be no danger to operator or patient. In spite of this, we feel it is our duty to mention the following safety measures in order to prevent any possible danger.

- When using this appliance all local and relevant regulations must be observed! Converting or modifying the appliance in any way is strictly prohibited. In such cases, any and all guarantees immediately become invalid. The operation of modified appliances can be punishable by law. In the interests of trouble-free operation the operator is responsible for observing these regulations.
- Retain the packaging for possible return of the product to the manufacturers. Ensure that the packaging is kept out of the reach of children. Only the original packaging provides adequate protection during transport of the unit. Should return of the product to the manufacturers be necessary during the guarantee period, Dürr Dental accepts no responsibility for damage occurring during transport where the original packaging was not used!
- Before every use the operator must check the functional safety and the condition of the appliance.
- The operator must be knowledgeable in the operation of the appliance.
- The product is not designed to be used in medical treatment areas where there exists the danger of explosion. Areas where explosions could occur are those where flammable anesthetic material, skin cleansers, oxygen and skin disinfectants are present. This appliance is not to be used in areas where the atmosphere could cause fire.

1.4 Notes on medical products

- This product is a technical medical appliance and, as such, may only be operated by such persons who, as a result of training or experience, can be confidently expected to operate it correctly and safely for patients and staff alike.
- Locally obtained multi-socket power supply extension cables should not be laid on the floor.
- Further electrical appliances must not be operated from the same multi-socket power supply extension cable.

1.5 Electrical safety instructions

- This appliance may only be operated from a correctly installed power outlet.
- Before connecting to the electricity supply the appliance must be inspected and checked that the supply voltage and the supply frequency correspond to that of the local electrical supply.
- Before initial use and start-up the appliance and all supply lines must be checked for any signs of damage. Damaged supply lines and connections must be replaced immediately.
- Never come into contact with patients and open plug-in connections on the appliance at the same time.
- When using the appliance observe all the relevant electrical safety procedures.
- Medical-electrical appliances are subject to special rules and regulations concerning EMC (electro-magnetic compatibility). All EMC notes contained in the documentation supplied must be carefully observed when such appliances are installed, commissioned and operated.
- Portable high-frequency communication appliances can affect electrical medical equipment.

1.6 Warnings and Symbols

In the operating instructions the following warnings and symbols have been used:



Information and/or mandatory regulations or prohibitions for the prevention of personal injury or substantial property damage



Information and/or instructions or prohibitions regarding personal safety or extensive material damage.



Warning - dangerous electrical voltage



Hot surface



For protection of operating personnel protective gloves must be worn when working with or on the Variosuc



Cold water should be sucked through the system



Observe Installation and Operating Instructions



Fuse



Disposable: only use once



Part type B



Appliance in operation



Appliance stops working



Audible signal / signal melody is heard

REF Type, order number

SN Serial number

2. Product Information

2.1 Correct Usage

The Variosuc is a mobile unit which has been designed especially to suck up spray mist and particles during dental treatment. During operation no water supply or water outlet is required, making the Variosuc an extremely flexible unit for implementation in dental clinics and dental surgeries.



See also the Installation and Operating Instructions supplied

2.2 Incorrect Usage

Any use of this appliance/these appliances above and beyond that laid down in the Installation and Operating Instructions is deemed to be incorrect usage. The manufacturer cannot be held liable for any damage resulting from incorrect usage. The operator will be held liable and bears all risks.

The Variosuc is not suitable for surgical areas.

3. Model Overview

Model 0624-100-50

(with both air-water-separation and amalgam separation)

Variosuc, complete with Combination Suction Unit VSA 300 S, 230 V 1~ / 50 Hz, hose manifold Comfort GFK and fluid container.

Model 0624-100-51

(with both air-water-separation and amalgam separation)

Variosuc, complete with Combination Suction Unit VSA 300 S, 230 V 1~ / 50 Hz, hose manifold Comfort GFGK with saliva funnel and fluid container.

Model 0624-100-55

(with air-water-separation)

Variosuc, complete with Combination Suction Unit VS 300 S, 230 V 1~ / 50 -60 Hz, hose manifold Comfort GFK and fluid container.

Model 0624-100-56

(with air-water-separation)

Variosuc, complete with Combination Suction Unit VS 300 S, 230 V 1~ / 50 -60 Hz, hose manifold Comfort GFGK with saliva funnel and fluid container.

4. Delivery Contents

Variosuc	0624-100-...
Transformer	9000-115-25
Orotol Plus test set	XX02-92-009
OroCup	0780-350-00
Test collector vessels set	0700-003-00
Transformer	0725-041-00
Rotating cover, grey	7600A010-04
Saliva extractor hose, grey	7600A020-50
Suction hose, grey	7600A010-50
Suction handpiece large, grey	7600A010-00
Suction handpiece small, grey	7600A020-00
Transformer	9000-317-22
Installation and Operating Instructions Variosuc	9000-606-40/..
Operating Instructions for Cleaning and Disinfection of suction systems	9000-605-10/..
Installation and Operating Instructions for hose manifold Comfort	9000-606-18/..

Optional depending on model

Installation and Operating Instructions VS 300 S	9000-606-22/..
Installation and Operating Instructions VSA 300 S	9000-606-31/..
Dürr Recycling Box (VSA 300 S only)	7110-010-00

4.1 Disposable materials

Orotol Plus	CDS110P6150
Orotol Ultra	CDS120U6701
MD 555 Orotol	CCS555C6100
Disposable filter for suction systems	0725-041-00
Transformer	7120-143-00
Universal cannula III, 20 pieces	0700-054-00
Surgical cannula Ø 5.0mm, 5 pieces	0700-005-00
Surgical cannula Ø 3.0mm, 5 pieces	0700-007-00

5. Technical Data



The Technical Data concerning the Combination Suction Unit and the Hose Manifold can be found in the Installation and Operating Instructions supplied.

Model 0624-100		-50 and -51	-55 and -56
Fuse systems			
IEC 60127-2/V		T 6,3 A H	T 6,3 A H
Weight	kg	32	32
Dimensions	(H x B x D) cm	92 x 36 x 60	92 x 36 x 60
Noise levels	dB(A)	54	54
Fuse type		IP 20	
Protection class		I	
Exhaust air connection		DürrConnect	
Waste water connection		DürrConnect	
Mesh size of the sieve/coarse filter in Combination Suction Unit	mm	3	3

* according to EN ISO 1680 Noise emissions; measured in sound-proofed room. The specifications are average values with tolerances approx. $\pm 1,5$ dB(A). Higher values may be obtained in reverberant rooms, i.e. rooms with little sound absorption.

5.1 Ambient conditions

Ambient conditions for storage and transport

Temperature (°C) -10 bis +60

Rel. humidity: max. 95 %

Ambient conditions in operation

Temperature (°C) +10 to +40

Rel. humidity: max. 70 %

6. Functional layout

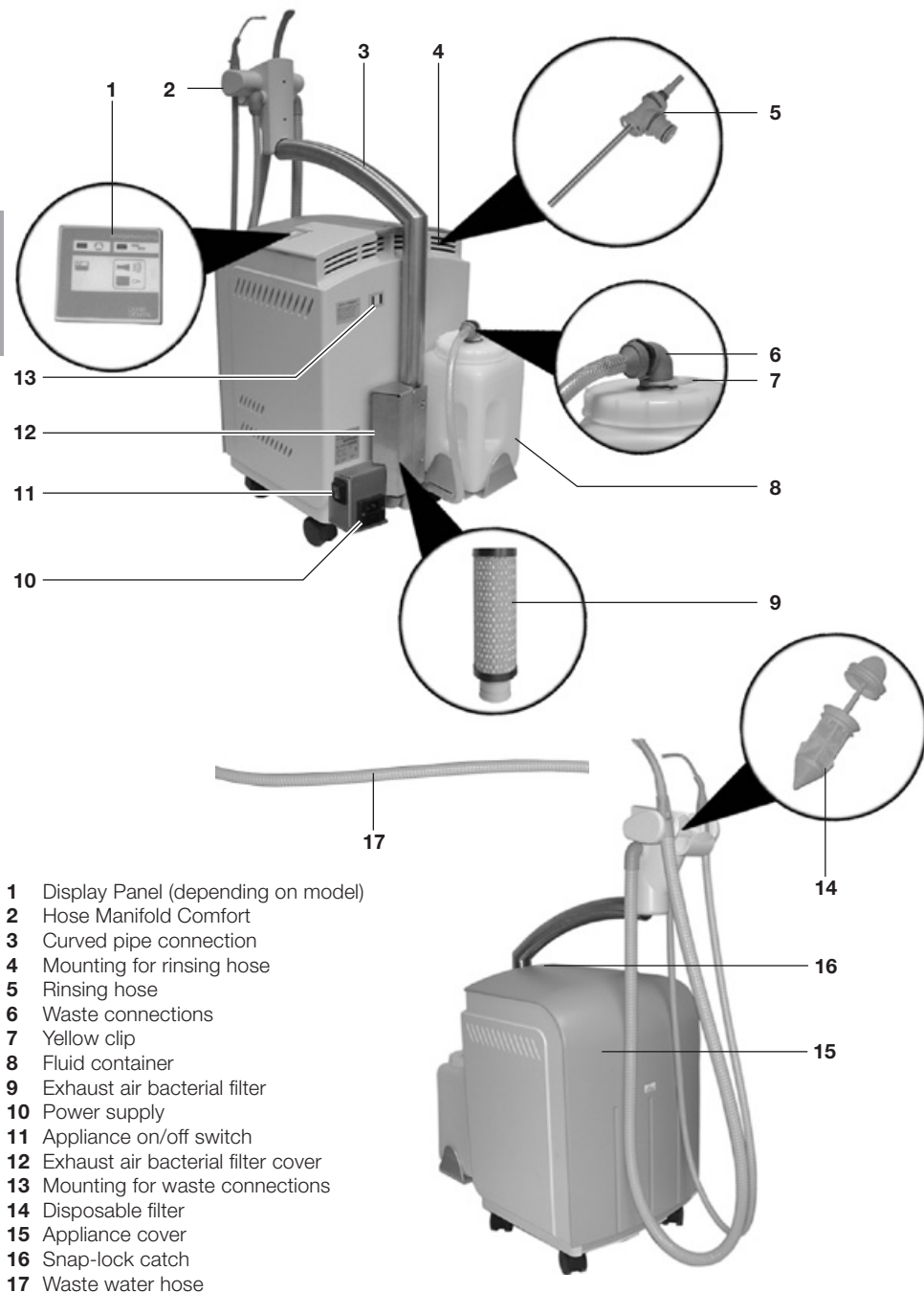

7. Functional Description

The Variosuc is supplied with and without amalgam separation depending on model type. The Dürr hose manifold (2) with selection control is mounted on the curved pipe (3). On the rear side of the Variosuc can be found the fluid container (8), into which the suction fluid is collected.

The fluid-air-mixture is flows through the hose manifold (2) and hence the yellow disposable filter (14), and is then transported via the hose in the curved pipe (3) to the Combination Suction Unit.

In the Combination Suction Unit the fluid is separated from the air and is then transported either to the fluid container (8) or directly via the waste water hose (17) into the waste water outlet.

The exhaust air is passed through the exhaust air bacterial filter (9) or, as an alternative for a fixed system installation, via an exhaust air hose. As soon as the maximum volume within the fluid container (8) has been reached, then the contents must be emptied. In the Variosuc with amalgam separation a Display Panel (1) is integrated in the cover which displays the level of the amalgam collector.

The Variosuc Suction System must be cleaned daily together with the Suction System and must be disinfected. Use Dürr Orotol Plus, Orotol Ultra or a comparable non-foaming disinfectant.

Cleaning of the disinfected Suction System must be carried out at least once a week and before any longer break in surgery hours. The completely empty and disinfected fluid container (8) should be filled with a solution of Dürr MD 555 and water, or with a comparable cleaning agent up to the marking.

Then close the cover of the fluid container. The rinsing hose (5) is now attached to the connection on the cover and connected to the waste connection (6). Now connect the large suction hose to the rinsing hose (5). Switching on the Variosuc at the main switch (11) causes the cleaning solution in the fluid container (8) to be sucked through the rinsing hose (5) into the suction system, and then back to the fluid container (8). The cleaning procedure requires approx. 20 minutes.

Subsequently, empty the fluid container (8), remove the rinsing hose (5) from the cover and clean both thoroughly.

Before working with the Variosuc the waste connections must be reconnected to the fluid container (8).

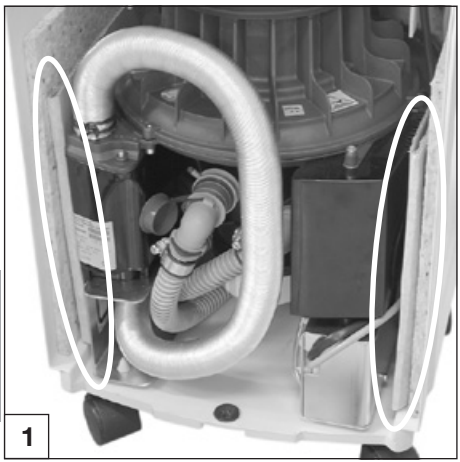

Mounting

8. Packing protection

The Combination Suction Unit in the Variosuc is fitted on both sides with box insert for protection during transport. These inserts must be removed before commissioning or starting work with the appliance.

- Lift the upper housing cover upwards and release the snap-lock (16).
- Remove the packing protection and close the appliance cover.

9. Set-up

- Before start-up and first use the supply voltage must be compared with the voltage instructions to be found on the model identification plate.
- In cold conditions allow sufficient time to elapse after transport for the appliance to warm to room temperature before commissioning or starting work (danger of a short circuit due to condensation)
- The Variosuc should be set up as close as possible to the treatment unit. Where a waste water connection is available, it is recommended that the fluids are fed directly via the waste water hose (17) into the waste water system.
Never apply pressure to the waste water hose!



10. Electrical Connection

Plug the power cable into the socket (10) on the rear side of the Variosuc. Plug the appliance into the mains power supply.

11. Final procedures

After set-up check all hoses and hoses for signs of leakages.

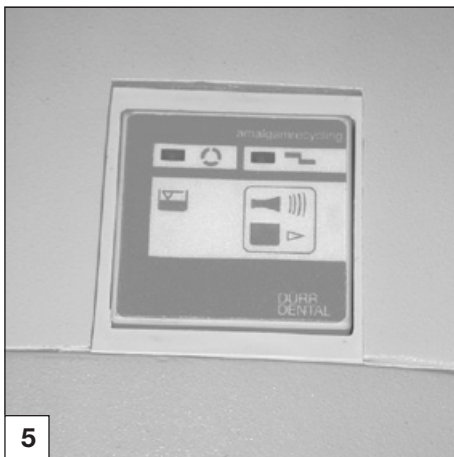
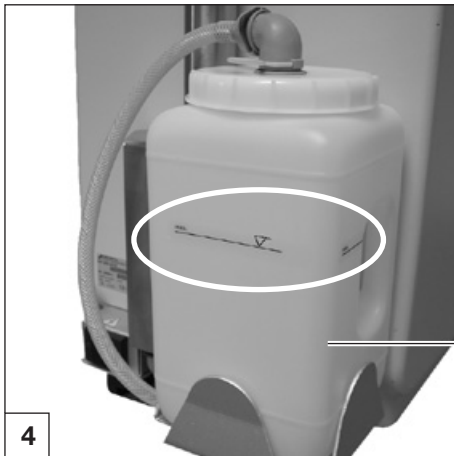
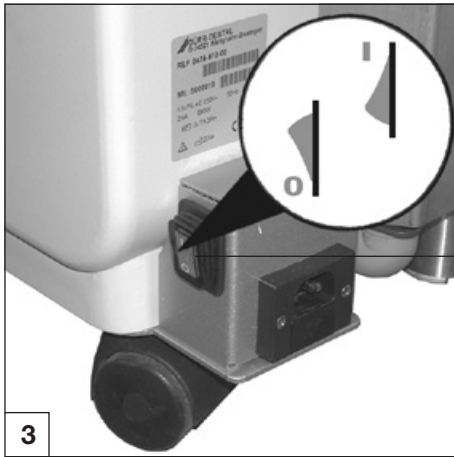

Use

12. Operating the Variosuc



The product is not designed to be used in medical treatment areas where there exists the danger of explosion. Areas where explosions could occur are those where flammable anesthetic material, skin cleansers, oxygen and skin disinfectants are present. This appliance is not to be used in areas where the atmosphere could cause fire.

12.1 Switching the Variosuc On and Off

Before beginning work using the Variosuc, switch on the main appliance switch (11). When on standby mode the green lamp on the display lights.

12.2 Suction of fluids

The Combination Suction Unit is automatically started by removing the suction hose from the hose manifold.



Fluids are sucked via the suction hose from the patient's mouth and collected in the fluid container (8).

During longer periods of treatment and at the end of treatment the level in the fluid container must be checked and the collector emptied when necessary.

12.3 Emptying the fluid container



The maximum level of fluid possible in the fluid container (8) is shown by a marking on the collector itself.

This collector must be emptied at least once every day. (see also section 13)

12.4 Display Panel (depending on model)



The function of the Display Panel is described fully in the Installation and Operating Instructions Dürr VSA 300 S order number 9000-606-31/.. .

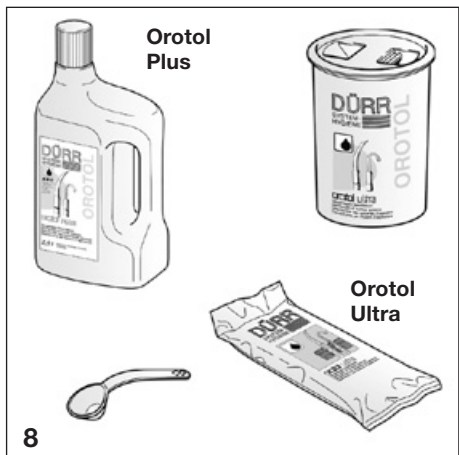
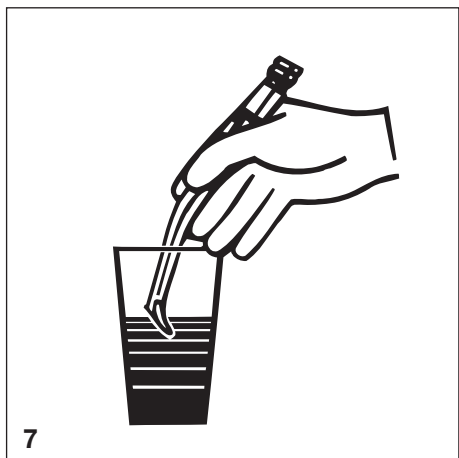
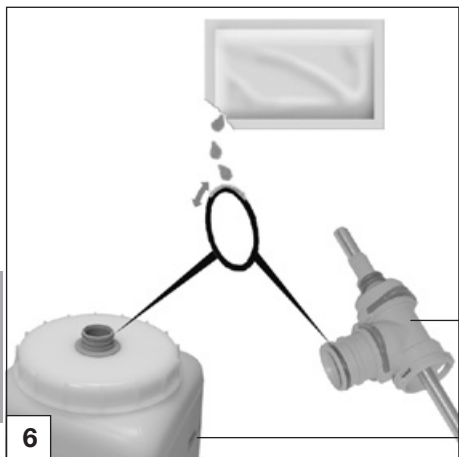

13. Disinfection and Cleaning

i Hygiene plan for Dental Practices. Observe the Installation and Operating Instructions supplied.

Lubricate the O-rings

In order to make uncoupling and coupling of the connections from rinsing hose (5) and the cover of the fluid container easier, we recommend that the O-rings are lubricated, e.g. with Vaseline, as necessary.

Fluid container

Empty, clean and disinfect the fluid container (8) daily, but also as soon as the marking for the maximum level has been reached.



Wear water-proof protective gloves

i If, during treatment, amalgam is extracted then it must be disposed of according to local rules and regulations.

13.1 For reasons of hygiene and perfect function, after every patient treatment

After every treatment we advise, for both hygiene and functional reasons, that a glass of cold water is sucked through both the large and the small suction hose - even if only the saliva extractor hose was operated.

i Aspiration using the larger suction hose allows a larger amount of fresh air (~300 l/min) to be drawn up and this increases considerably the cleaning efficiency.

The surface of the Variosuc must be cleaned and disinfected using a non-aggressive disinfection cloth, e.g. FD 350 or a comparable product.

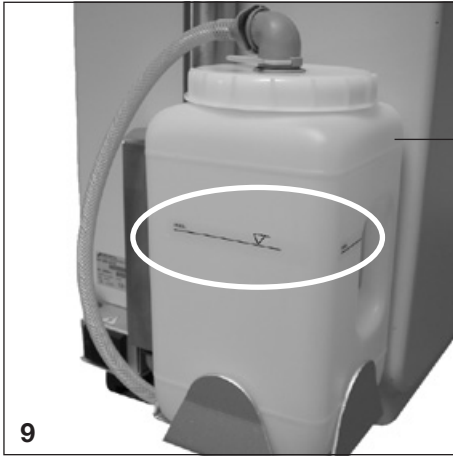

13.2 Before lunch break and at the end of the day

Before the lunchbreak and after surgery hours have finished the suction system must be cleaned and disinfected by suction of OROTOL Ultra or OROTOL Plus.



Do not use any foaming agent, e.g. household cleaning agent, instrument disinfection agent or abrasive cleaners.

Do not use agents containing chlorine or any sort of solvent such as acetone. These chemical agents can damage parts of the appliance. The guarantee does not cover the use of incorrect cleaning and disinfectant agents.

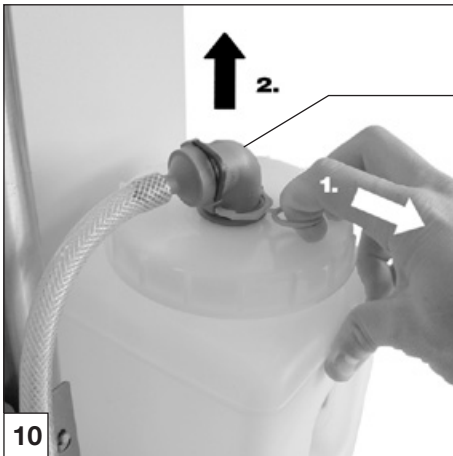

13.3 Weekly and before longer surgery holidays

The Variosuc must be thoroughly rinsed through at least once a week and before longer surgery breaks such as holidays using the rinsing hose (5) for c. 20 min.



Wear water-proof protective gloves

- Remove the yellow clip from the waste connection (6) on the lid of the collector. Gently twist and pull the waste connection (6) from the lid in an upward direction and remove.
- To prevent fluid escaping from the waste connection (6) this must be placed in the mounting (13).



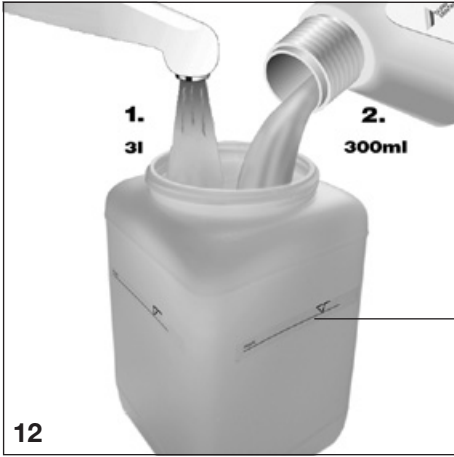

- Unscrew the container lid, empty the fluid from the fluid container (8) and rinse thoroughly with water.
- Fill the fluid container (8) up to the maximum level with water.



The max. level is 3 litres

8

- Add a suitable suction unit cleaner (e.g. Dürr MD 555 in 10 % concentration, i.e. 300ml to 3L water) to the water.
- Screw the lid of the collector back on.
- Remove the rinsing hose (5) from its mounting (4), place it onto the connector on the cover, twist gently until in position and secure using the yellow retaining clip.
- Connect the waste connection (6) onto the rinsing hose (5), and secure using the yellow retaining clip.
- Switch on the Variosuc at the main switch (13).
- Remove the cannula from the large suction handpiece.
- Place the large suction handpiece onto the rinsing hose (5) (fig. 13).

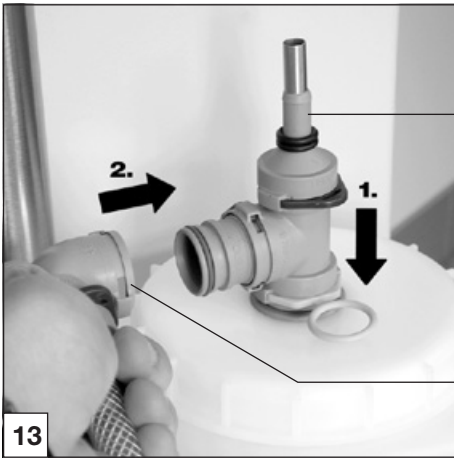

5



The system will now be efficiently cleaned automatically.

6

- After approx. 20 min. remove the suction handpiece **slowly** from the connection on the rinsing hose (5) and place in the hose manifold.
- Remove the rinsing hose (5) from the fluid container (8) and clean and disinfect using a suitable instrument disinfectant, e.g. ID 212 forte or ID 213.
- Replace the waste water hose on to the empty and disinfected fluid container.

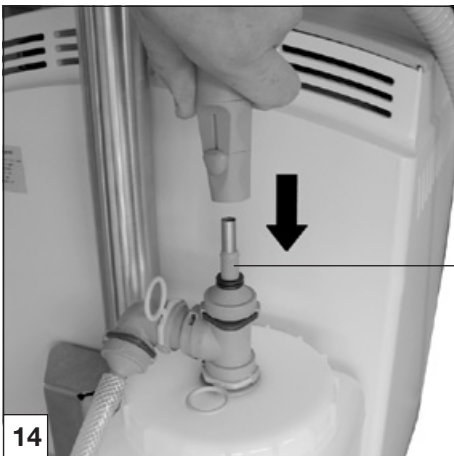

5

14

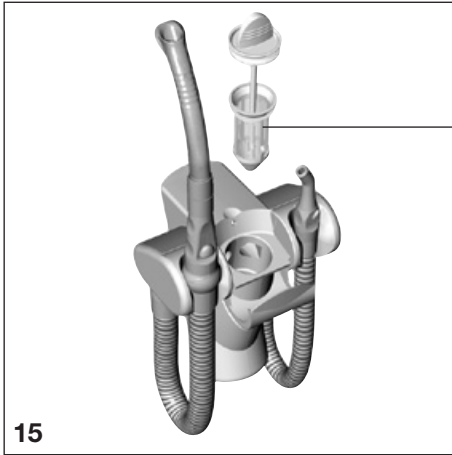

15

14. Changing the filter

14.1 Filter change - 1 x week

 In order to reduce any danger of infection during repairs or maintenance always wear waterproof protective gloves. (BGV C8 §5 and 7)

Open the middle cover of the hose manifold unit and change the yellow disposable filter (14). Detailed descriptions regarding changing the filter are supplied in each filter pack.



Never work without a filter, otherwise there is the danger that particles will settle at awkward positions in the hose manifold and cause the unit to malfunction.

The filter is a disposable filter and must not be reused. The maximum operating temperature of the filter and filter cover is approx. 60 °C.

Reorder:

Disposable filter (12 pieces) order number 0725-041-00

14.2 Exhaust air germ filter

The exhaust air bacterial filter (9) must be **replaced every year**.

The exhaust air bacterial filter does not prevent odours! If there are bad smells then the complete suction system should be cleaned using a suction unit cleaning agent, e.g. MD 555 (see 13.3).



Supplied with every bacterial filter are two stickers: one round and one rectangular. These two stickers must be filled **inbefore commissioning** the Variosuc, i.e. before first use.

The round sticker must be placed on the bacterial filter (9), the rectangular sticker is stuck into the surgery hand-book.

The stickers serve to remind operating personnel when to change the filter.

- In order to change the filter lift the cover plate (12) upwards out of its mounting.
- Remove the upper blue clip (18) and remove the bacterial filter (9) from its support.
- Mount the bacterial filter (9) and carry out previous steps in reverse order.

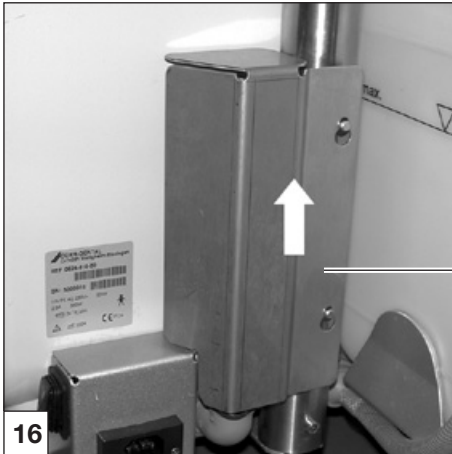

16



17

15. Electrical Connection



Further information can be found in the Installation and Operating Instructions supplied with the Combination Suction Unit VS 300 S order number 9000-606-22 and VSA 300 S order number 9000-606-31.

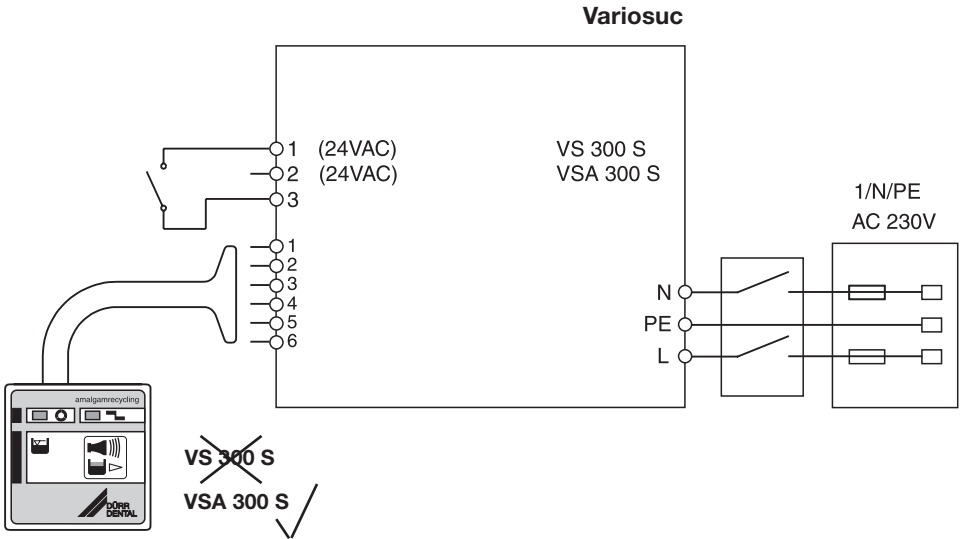



Disposal

16. Appliance disposal

The Suction Unit causes heavy metals and amalgam dust in the form of fillings to be extracted. In order to reduce the heavy metal contamination in the waste water from dental treatment stations, this waste water must be disposed of in accordance with the valid waste water rules and regulations of the relevant country.

Those parts which are contaminated with amalgam such as coarse filters, filters and hoses etc. should be disposed of according to local and national regulations.

The Variosuc can be disposed of in accordance with the valid rules and regulations of the country concerned.

The control board, PCB and components should be disposed of as electronic waste.

DÜRR DENTAL AG
Höpfigheimer Strasse 17
74321 Bietigheim-Bissingen
Germany
Fon: +49 7142 705-0
www.duerr.de
info@duerr.de

