

# USE and MAINTENANCE MANUAL

## **SterilClave<sup>®</sup> 18 / 24** -Steam sterilizer-



### **FOREWORD**

This manual must be considered an integral part of the sterilizer, and must always be available to users. The manual must always accompany the sterilizer, even if it is sold to another user.

All operators are responsible for reading this manual and for strictly complying with the instructions and information it provides. **COMINOX** is not liable for any damage to people, things, or the sterilizer itself in the event that the operator fails to comply with the conditions described in the manual.

These instructions are confidential and the customer may not disclose any information to third parties. Further, this documentation and its attachments may not be tampered with or modified, copied, or ceded to third parties without authorization from **COMINOX**.



## TABLE OF CONTENTS

<b>TABLE OF CONTENTS</b> .....	<b>3</b>
Reference index .....	6
Graphic representation of references Mod. 18 .....	7
Graphic representation of references Mod. 24 .....	8
<b>INTRODUCTION</b> .....	<b>9</b>
GENERAL SUPPLY CONDITIONS.....	9
PURPOSE OF THE DOCUMENT .....	10
EQUIPMENT.....	10
OPERATING USE.....	11
Table of cycles/sterilizable material 18B - 18BHD .....	12
Table of cycles/sterilizable material 18S .....	13
Table of cycles/sterilizable material 24B - 24BHD .....	13
<b>TECHNICAL SPECIFICATIONS</b> .....	<b>15</b>
Technical specifications table 18 .....	15
Technical specifications table 24 .....	16
REFERENCE STANDARDS.....	16
DIMENSIONS.....	17
General dimensions .....	17
Dimensions required when the unit is to be built-in .....	17
<b>GENERAL SAFETY CONDITIONS</b> .....	<b>18</b>
Thermal danger .....	18
Noise .....	18
Environmental conditions and risks.....	19
Residual risks table .....	19
<b>TRANSPORTATION AND PACKAGING</b> .....	<b>20</b>
Unpacking and cleaning the components.....	20
Storage .....	21
<b>INSTALLATION</b> .....	<b>22</b>
GENERAL CONDITIONS .....	22
Arrangement.....	22

CONNECTIONS .....	23
Electrical connections .....	23
Water connection .....	23
Water supply table .....	24
MANUALLY FILL CLEAN WATER TANK .....	25
MANUALLY DRAIN TANKS.....	25
PREPARING FOR BUILT-IN INSTALLATION .....	25
<b>OPERATION .....</b>	<b>26</b>
SWITCH-ON .....	26
STAND BY .....	28
MENU.....	29
1. Cycle Menu.....	30
2. Main Settings Menu.....	30
2.1 Language .....	31
2.2 Date and Time .....	31
2.3 Button Sound.....	31
2.4 Self-stop.....	31
2.5 Self-filling .....	32
2.6 Printer.....	32
2.7 Cycle Recording .....	32
2.8 Data Logging.....	32
3. Advanced Tools Menu .....	32
3.1 Prog. SPECIAL .....	33
3.2 Programmed start .....	34
3.3 Hollow Loads .....	35
3.4a Change sec. Code .....	35
3.4b SterilCard Option.....	36
3.4b.1 Create User .....	36
3.4b.2 Delete User .....	39
3.4b.3 Enable User.....	40
4. Cycle Records Menu .....	41
5. Maintenance Menu .....	42
5.1 Items .....	42
5.2 Save Maintenance .....	43
INFORMATION in STAND BY .....	44
STARTING the CYCLE .....	44
STOP the CYCLE .....	45
EVENTS in the CYCLE .....	47
INFORMATION about the CYCLE .....	48
PLOT of the CYCLE.....	48
CONTROL TESTS .....	49
Bowie & Dick test .....	49
Vacuum test .....	49
Helix test .....	51

Printer .....	51
Cycle Recording on SterilCard .....	52
<b>INDICATORS</b> .....	<b>54</b>
<b>ALARMS</b> .....	<b>56</b>
List of alarm codes .....	61
<b>MAINTENANCE</b> .....	<b>62</b>
GENERAL CONDITIONS .....	62
Cleaning.....	62
Filters.....	63
Checks.....	63
Fuses.....	63
STORAGE AND DISPOSAL.....	64
Sterilizer storage or long-term disuse .....	64
Disposal and scrapping.....	64
Maintenance schedule table .....	65
<b>APPENDIX 1: GRAPHICS 18 B – 18 BHD / 24B – 24 BHD</b> .....	<b>66</b>
<b>APPENDIX 2: GRAPHICS 18 S</b> .....	<b>67</b>

## Reference index

- 01: tray handle*
- 02: waste pipe*
- 03: power cable*
- 04: tray*
- 05: metering funnel*
- 06: SterilCard*
- 07: pouch holders*
- 08: support for 5 trays or 3 cassettes*
- 09: chamber*
- 10: clean water tank*
- 11: waste water recovery tank*
- 12: safety valve*
- 13: main switch*
- 14: filler*
- 15: air sterilization filter*
- 16: door*
- 17: safety thermostat*
- 18: print door*
- 19: coil covering grid*
- 20: waste filter*
- 21: chamber probe*
- 22: adjustable feet*
- 23: lifting straps*
- 24: clean water tap*
- 25: waste water tap*
- 26: printer*
- 27: level testing pipe*
- 28: grid seal*
- 29: auto water fill*
- 30: direct drain*
- 31: door gasket*
- 32: fuses*

Graphic representation of references Mod. 18

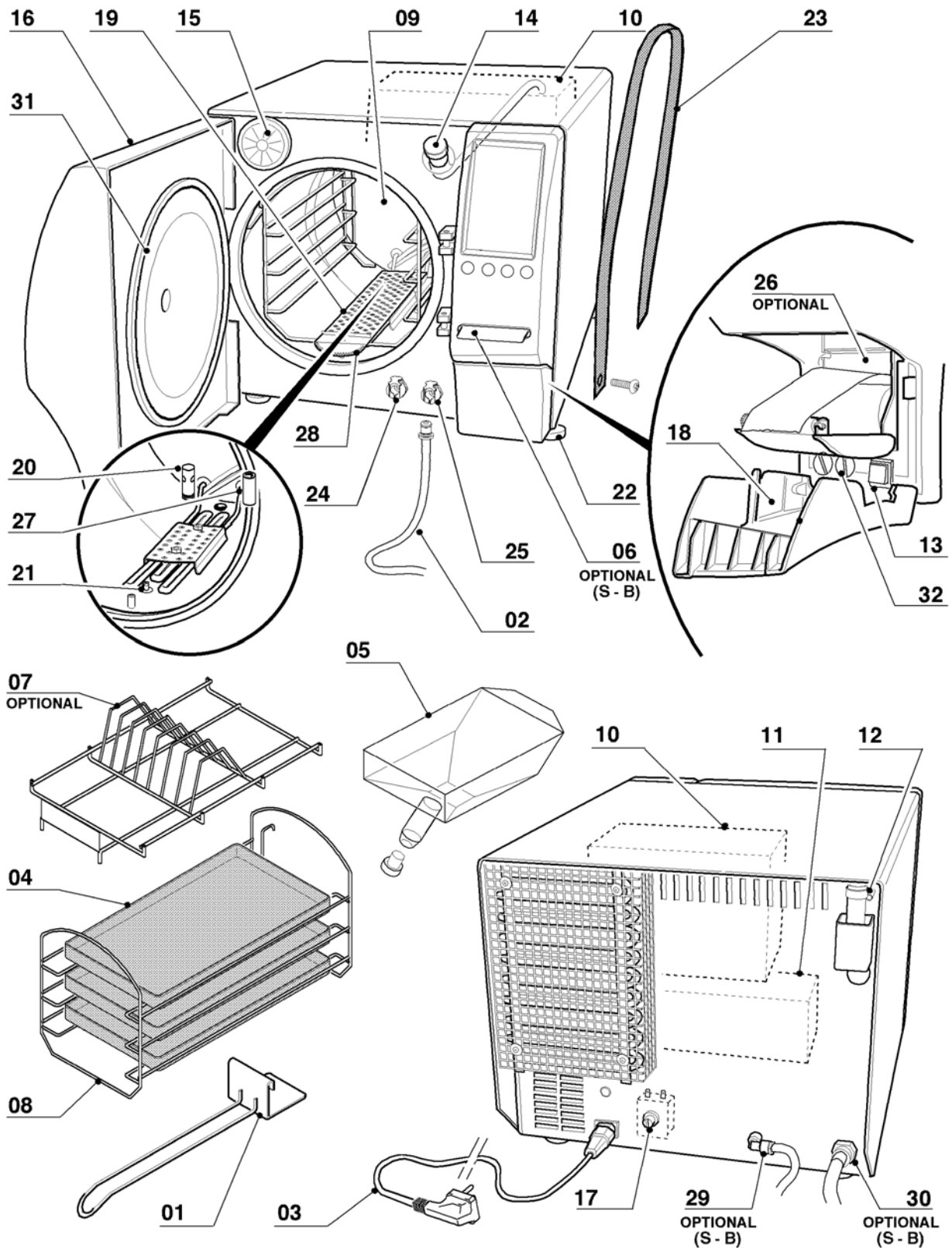

Graphic representation of references Mod. 24

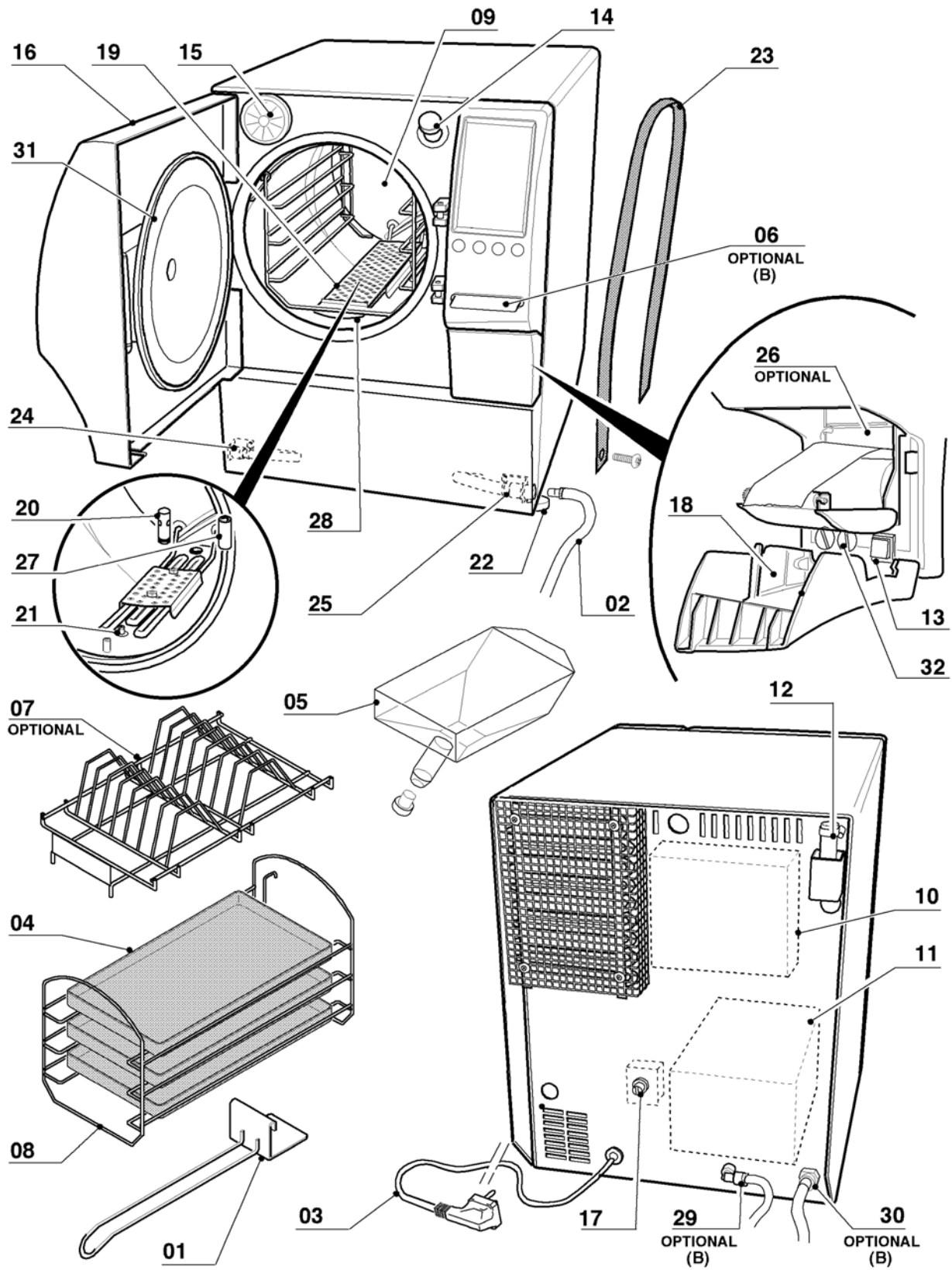



## INTRODUCTION

### GENERAL SUPPLY CONDITIONS

**COMINOX** declares that the sterilizer complies with the standards and regulations in force in the European Economic Community and issues the attached DECLARATION OF CONFORMITY.

**COMINOX** will repair any manufacturing defects that arise **within 24 months** from the time the sterilizer is installed (refer to the Guarantee). The *chamber 09* is guaranteed for 10 years.

The customer must use original spare parts only and fit them according to their intended use.

**Responsibility for commercial components lies with their manufacturers.**

**COMINOX** is not liable for defects or malfunctions deriving from improper use of the sterilizer, changes that occur during transportation, or those caused by specific environmental conditions, lack of maintenance or maintenance conducted improperly, or problems due to tampering or incorrect repairs.

**COMINOX** declines all responsibility if the sterilizer is not installed properly or if it is not installed by duly trained and qualified personnel.

**COMINOX** IS NOT responsible for the disposal of the products required for the transport or operation of the sterilizer or for production materials: packaging, waste water, lubricants, etc. The customer is individually responsible, under the specific regulations and standards in force in each installation country, for disposing of any substances that are potentially harmful to the environment.

**The same precautions apply to scrapping the sterilizer.**

## PURPOSE OF THE DOCUMENT

This Use and Maintenance Manual aims to provide the operator with a useful guide for:

- understanding the correct procedures for installing the sterilizer;
- explaining the various SterilClave functions;
- ensuring optimal use of the sterilizer;
- operating in complete safety;
- conducting the maintenance required for proper upkeep of the sterilizer.

## EQUIPMENT

In addition to this Use and Maintenance Manual, each sterilizer is supplied with a Guarantee Certificate and the EC Declaration of Conformity.

The Cominox SterilClave sterilizer also includes the following accessories:

	#	18S	18B - 24B	18BHD - 24BHD
<i>Tray handle 01</i>	1	•	•	•
<i>Waste pipe 02</i>	1	•	•	•
<i>Level testing pipe 27</i>	1	•	•	•
<i>Grid seal 28</i>	1	•	•	•
<i>Power cable 03</i>	1	•	•	•
<i>Trays 04</i>	3	•	•	•
<i>Pouch holders 07</i>	1	optional	optional	optional
<i>Support for 5 trays or 3 cassettes 08</i>	1	•	•	•
<i>Metering funnel 05 with cap</i>	1	•	•	•
<i>Administrator and User SterilCards 06</i>	2	optional	optional	•
<i>Printer 26</i>	1	optional	optional	optional
<i>Auto water fill 29</i>	1	optional	optional	•
<i>Direct drain 30</i>	1	optional	optional	•

• Supplied as standard

## OPERATING USE

Under no circumstances should the sterilizer or its parts be used for any purpose other than those described below.

The sterilizer was designed to:

**STERILIZE**  
**AUTOCLAVABLE SURGICAL, DIAGNOSTIC OR MEDICAL INSTRUMENTS**  
 for example: **SCISSORS, SCALPEL, GAUZE, FABRICS**

Various types of materials can be sterilized, such as: stainless steel, glass, rubber, plastic, cotton, fabrics in general.

**!** *Check that the product to be sterilized can withstand a temperature higher than the temperature of the programmed cycle.*  
*Observe the normal usage conditions described. **COMINOX** guarantees that the maximum measurable temperature in chamber **09** will be: PROGRAMMED STERILIZATION TEMPERATURE -0°C/+4°C (as stated in EN 13060).*

The EN 13060 standard distinguishes various types of load depending on the material to be sterilized: solid loads (e.g. scalpels), hollow loads of type A or type B (e.g. surgical extraction cannula) and porous loads (e.g. fabrics and gauzes). This division should guide the operator in selecting the sterilization cycle (see Table of cycles/sterilizable material). Strictly comply with the sterilization instructions and information specified by the

**!** *Instruments and fabrics to be sterilized **MUST** be carefully washed, rinsed with additive-free water and dried. The support for the load must also be perfectly dry.*

manufacturer for any material to be sterilized.

Comply with the maximum total load weight (see Table of cycles/sterilizable material).

Use the load support system supplied by **COMINOX**. Use of load supports other than the standard support provided may compromise the steam penetration and drying performance confirmed during approval tests.

Follow instructions concerning correct packaging, and only use packaging materials compliant with standard EN 868.

**!** *The sterilizer may **NOT** be operated or installed in areas in which gas or any other explosive volatile substance is present.*

**!** *For every sterilization cycle, introduce a chemical process indicator in the load or in each packaging. It verifies the sterilization process through the colour change when the sterilization values for time, temperature and steam saturation are reached.*  
*In the end of the cycle, check the chemical indicator to monitor the reaching of the correct sterilization conditions in the chamber **09**.*

Table of cycles/sterilizable material 18B - 18BHD

	121 UN-WRAPPED	134 UN-WRAPPED	134 WRAPPED	121 POROUS / HOLLOW	134 POROUS / HOLLOW	134 PRION	BOWIE & DICK TEST	VACUUM TEST	
Type according to EN 13060	N	N	S1	B	B	B			
Temperature	121°C	134°C	134°C	121°C	134°C	134°C	134°C	-	
Pressure	2.1 bar	3.1 bar	3.1 bar	2.1 bar	3.1 bar	3.1 bar	3.1 bar	-	
Duration of sterilization phase	15'	4'	4'	15'	4'	18'	3.5'	-	
Drying	no	no	20'	20'	20'	20'	no	no	
Total duration (minimum - maximum)	23' - 30'	13' - 21'	37' - 48'	57' - 77'	49' - 69'	63' - 85'	25'	20'	
Load:									
solid	yes	yes	yes	yes	yes	yes	empty chamber	empty chamber	
porous	no	no	no	yes	yes	yes			
hollow A	no	no	no	yes	yes	yes			
hollow B	no	no	no	yes	yes	yes			
Packaging:									
not packaged	yes	yes	yes	yes	yes	yes	empty chamber	empty chamber	
single pack	no	no	yes	yes	yes	yes			
double pack	no	no	no	yes	yes	yes			
Maximum load weight (solid/hollow - porous)	5 Kg	5 Kg	3 Kg	2.5 - 1.5 Kg	2.5 - 1.5 Kg	2.5 - 1.5 Kg	-	-	

Table of cycles/sterilizable material 18S

	121 UN-WRAPPED	134 UN-WRAPPED	134 WRAPPED	121 POROUS/HOLLOW	134 POROUS/HOLLOW	134 PRION	BOWIE & DICK TEST	VACUUM TEST
Type according to EN 13060	N	N	S1	S2	S2	S2		
Temperature	121°C	134°C	134°C	121°C	134°C	134°C	134°C	-
Pressure	2.1 bar	3.1 bar	3.1 bar	2.1 bar	3.1 bar	3.1 bar	3.1 bar	-
Duration of sterilization phase	15'	4'	4'	15'	4'	18'	3,5'	-
Drying	no	no	25'	25'	25'	25'	no	no
Total duration (minimum - maximum)	24' - 29'	14' - 19'	44' - 54'	59' - 70'	50' - 59'	64' - 74'	25'	20'
Load:								
solid	yes	yes	yes	yes	yes	yes	empty chamber	empty chamber
porous	no	no	no	yes	yes	yes		
hollow A	no	no	no	no	no	no		
hollow B	no	no	no	yes	yes	yes		
Packaging:								
not packaged	yes	yes	yes	yes	yes	yes	empty chamber	empty chamber
single pack	no	no	yes	yes	yes	yes		
double pack	no	no	no	no	no	no		
Maximum load weight (solid/hollow - porous)	5 Kg	5 Kg	3 Kg	2.5 - 1 Kg	2.5 - 1 Kg	2.5 - 1 Kg	-	-

Table of cycles/sterilizable material 24B - 24BHD

	121 UN-WRAPPED	134 UN-WRAPPED	134 WRAPPED	121 POROUS/HOLLOW	134 POROUS/HOLLOW	134 PRION	BOWIE & DICK TEST	VACUUM TEST
Type according to EN 13060	N	N	S1	B	B	B		
Temperature	121°C	134°C	134°C	121°C	134°C	134°C	134°C	-
Pressure	2.1 bar	3.1 bar	3.1 bar	2.1 bar	3.1 bar	3.1 bar	3.1 bar	-
Duration of sterilization phase	15'	4'	4'	15'	4'	18'	3,5'	-
Drying	no	no	20'	20'	20'	20'	no	no
Total duration (minimum - maximum)	21' - 28'	11' - 19'	37' - 49'	60' - 79'	49' - 73'	66' - 88'	25'	20'
Load:								
solid	yes	yes	yes	yes	yes	yes	empty chamber	empty chamber
porous	no	no	no	yes	yes	yes		
hollow A	no	no	no	yes	yes	yes		
hollow B	no	no	no	yes	yes	yes		
Packaging:								
not packaged	yes	yes	yes	yes	yes	yes	empty chamber	empty chamber
single pack	no	no	yes	yes	yes	yes		
double pack	no	no	no	yes	yes	yes		
Maximum load weight (solid/hollow - porous)	7.5 Kg	7.5 Kg	4 Kg	3.7 - 2.2 Kg	3.7 - 2.2 Kg	3.7 - 2.2 Kg	-	-

## NOTE

**CYCLE N:** sterilization cycle for solid instruments, unpackaged only.

**CYCLE S1:** sterilization cycle for solid instruments, packaged or unpackaged.

**CYCLE S2:** sterilization cycle for solid instruments, porous loads, and hollow loads type B, packaged or unpackaged.

**CYCLE B:** sterilization cycle for solid instruments, porous loads, and hollow loads type A or B, packaged or unpackaged; double packaging is also permitted.

**TYPE A HOLLOW LOADS:** instruments with an open cavity on one side only, where the length to cavity diameter ratio is greater than or equal to 1 and less than or equal to 750 ( $1 \leq L/D \leq 750$ ), and where the length of the cavity is no longer than 1500 mm ( $L \leq 1500$  mm). Alternatively, instruments with an open cavity on both sides, whose length to cavity diameter ratio is greater than or equal to 2 and less than or equal to 1500 ( $2 \leq L/D \leq 1500$ ), and where the length of the cavity is no longer than 3000 mm ( $L \leq 3000$  mm).

**TYPE B HOLLOW LOADS:** instruments with an open cavity on one side only, where the length to cavity diameter ratio is greater than or equal to 1 and less than or equal to 5 ( $1 \leq L/D \leq 5$ ), and where the diameter of the cavity is greater than or equal to 5 mm ( $D \geq 5$  mm). Alternatively, instruments with an open cavity on both sides, whose length to cavity diameter ratio is greater than or equal to 2 and less than or equal to 10 ( $2 \leq L/D \leq 10$ ), and where the diameter of the cavity is greater than or equal to 5 mm ( $D \geq 5$  mm).

**MAXIMUM LOAD WEIGHT:** the maximum weight permitted for each load category described, including the load support system and its packaging.

**TOTAL MAXIMUM DURATION:** the total time the sterilizer requires to run a complete cycle, calculated from cold start-up (room temperature) and maximum load.

**TOTAL MINIMUM DURATION:** the total time the sterilizer requires to run a complete cycle, including hot start-up (one cycle after the other) and minimum load (load support only).

## TECHNICAL SPECIFICATIONS

**Technical specifications table 18**

	<b>U.M.</b>	<b>S</b>	<b>B</b>	<b>BHD</b>
Steam generation		in chamber	in chamber	in chamber
Chamber capacity	l	17,15		
Clean water tank capacity	l	2,1		
Waste water recovery tank capacity	l	2,1		
Water consumption per cycle (minimum/maximum)	cm <sup>3</sup>	180 - 500	210 - 700	210 - 700
Minimum water load	cm <sup>3</sup>	500	700	700
Maximum flow discharge rate (direct)	cm <sup>3</sup> /s	30		
Maximum discharge temperature (direct)	°C	83		
Absolute operating pressure (maximum)	kPa	331		
Electrical voltage and frequency	V - Hz	230 – 50/60 (single-phase AC)		
Maximum allowed voltage fluctuations	%	±10		
Absorbed maximum power	W	2000		
Heat emission	J/h	0,3		
Detected noise level in work areas under suitable conditions (medium-peak)	dB(A) - dB(C)	55,7 – 62,7		
Weight (mass)	kg	48,7	51	51
Weight per support area with full tank and maximum load	kg/cm <sup>2</sup>	1,16	1,2	1,2
Room temperature allowed	°C	from 15 to 40		
Maximum relative humidity allowed	%	85		
Maximum altitude allowed with standard safety valve	m asl	1500 (2000 with replacement of the valve)		
Conditional connections: maximum impedance	Ω	0.139+j0.087		

**Technical specifications table 24**

	U.M.	B	BHD
Steam generation		in chamber	in chamber
Chamber capacity	l	23,15	
Clean water tank capacity	l	3,1	
Waste water recovery tank capacity	l	3.1	
Water consumption per cycle (minimum/maximum)	cm <sup>3</sup>	420-1040	420-1190
Minimum water load	cm <sup>3</sup>	1040	1190
Maximum flow discharge rate (direct)	cm <sup>3</sup> /s	30	
Maximum discharge temperature (direct)	°C	83	
Absolute operating pressure (maximum)	kPa	331	
Electrical voltage and frequency	V - Hz	230 – 50/60 (single-phase AC)	
Maximum allowed voltage fluctuations	%	±10	
Absorbed maximum power	W	2800	
Heat emission	J/h	0.3	
Detected noise level in work areas under suitable conditions (medium-peak)	dB(A) - dB(C)	56 - 63	
Weight (mass)	kg	63	68
Weight per support area with full tank and maximum load	kg/cm <sup>2</sup>	1.53	1.63
Room temperature allowed	°C	from 15 to 40	
Maximum relative humidity allowed	%	85	
Maximum altitude allowed with standard safety valve	m asl	1500 (2000 with replacement of the valve)	
Conditional connections: maximum impedance	Ω	0.153+j00.096	

## REFERENCE STANDARDS

SterilClave sterilizers were conceived and designed in conformity with the following directives and standards:

### Directives

- 97/23/CE Pressure equipment
- 93/42/EEC Medical devices (class II a)
- 89/336/CEE Electromagnetic compatibility (and subsequent updates)
- 73/23/CEE Low voltage (and subsequent updates)

### Standards

- EN 13060 Small steam sterilizers
- EN 61010-1 Safety regulations for laboratory devices - Part 1: General regulations
- EN 61010-2-040 Safety regulations specific to sterilizers used in the processing of medical material.
- EN 61326-1 Electromagnetic compatibility regulations for laboratory devices



## DIMENSIONS

### General dimensions

	<b>SterilClave 18</b>	<b>SterilClave 24</b>
A - Width	445	445
B - Height	390	470
C - Depth	640	700
D - Unit depth with door open	880	940

### Dimensions required when the unit is to be built-in

	<b>SterilClave 18</b>	<b>SterilClave 24</b>
E - Width	450	450
F - Height	395	475
G - Depth	560	620



*NEVER place the sterilizer on soft surfaces (such as cloth or foam) and never remove the adjustable feet.*

*Leave approximately 20 mm of space for rear ventilation. Built-in units require an additional 20 mm between the unit and the wall. In this case, the unit must have a rear opening for ventilation.*

### Usable space dimensions

	<b>SterilClave 18</b>	<b>SterilClave 24</b>
H - Width	185	185
I - Height	150	150
L - Depth	285	420

## GENERAL SAFETY CONDITIONS

- Switch off the sterilizer at the *main switch 13* and disconnect the *power cable 03* before conducting any operations apart from those in the normal operations cycle.
- The main power supply must be properly grounded.
- It is essential that operators are properly educated. It is therefore compulsory for them to read and comply with the technical information provided in the manual and attached documentation. The use of unqualified personnel is strictly prohibited.
- Personnel who operate the sterilizer must always use the appropriate individual protective devices: gloves for sharp or pointed objects and heated elements, and the special tray handle for emptying the chamber.
- Avoid any temporary repairs: repairs must be performed exclusively with original spare parts, and these must be installed by an authorized technician.
- Never remove or dismantle any part from the sterilizer. Only authorized personnel trained in advance by **COMINOX** may remove the exterior protective cover and access the interior parts.
- Labeling plates on the unit should not be removed, damaged, or dirtied. They must be kept clean and clearly visible.
- Do not use the sterilizer if there are possible defects in its operation.
- The sterilizer should be cleaned using suitable means and detergents that will not damage or corrode any sterilizer components. It is strictly forbidden to clean or wash the sterilizer with jets of water.
- Never place containers of liquids on the sterilizer or the shelves above it. Leakage or spillage on the electric system can cause a short circuit.
- Do not place flammable or toxic materials and products for sterilization in the *chamber 09*.
- Do not use the sterilizer to process containers that hold fluids, whether they are sealed or not.
- Never lean on the *door 16*.

The information in this manual does not replace any safety instructions or technical data for installation and operation on the unit itself, nor any safety standards in force in the installation country, or the rules of common sense.

### Thermal danger

Interior parts of the *door 16* and of the *chamber 09* can reach extremely high temperatures.

Never touch the heated surfaces until they have cooled, and always use the appropriate protective gloves. The same applies when a load is to be removed from the sterilization chamber. To remove the *trays 04* holding the load, always use the *tray handle 01*. Never leave the tray handle inside the sterilization chamber.



*When opening the door 16, steam may escape, which could cause burns.  
Never stand in front of or above the door!*

The temperature in the sterilization chamber is controlled by a *safety thermostat 17* that intervenes if overheating occurs. The safety thermostat must be reset manually.

### Noise

The sound pressure level (*noise*) detected in suitable work spaces must be lower than 70dB(A).

## Environmental conditions and risks

The sterilizer may not be installed in the open or be exposed to unfavourable weather conditions (sun, rain, snow, wind).



*In addition, make sure that there is no electromagnetic interference that could affect the data in the electronic devices.*



*The unit is not equipped as standard for operation in environments that present a particular risk of fire or explosion.*

**COMINOX** is not liable for the disposal of materials required for the operation or production of the sterilizer (e.g.: **plastic packaging or potentially contaminated waste water...**). The client must personally provide for the removal of any substances that are potentially harmful to the environment in compliance with regulations in force in the country of installation.

The same precautions apply to scrapping the sterilizer.

The sterilizer was designed in compliance with best practices concerning energy conservation, preventing needless waste.

## Residual risks table

RISK ANALYSIS AND DESCRIPTION	SUGGESTED REMEDY
Losses or leaks with risks of slipping, short circuit or pollution.	Carefully clean the workplace.
Drainage of waste water contaminated by viruses, bacteria, or pathogenic micro-organisms.	Dispose of according to the regulations in force.
Escaping steam and/or gas fumes when opening the <i>door 16</i> .	Always carefully check whether the load complies with cycle temperatures, and open the door with caution.
Excessively hot surfaces, especially in the sterilization <i>chamber 09</i> and on certain solenoid valves or internal components.	Wear protective gloves and/or never touch any internal components unless duly AUTHORIZED.
The chamber seal is hermetic even when the unit is switched off; plants and animals cannot survive inside the sterilizer.	Do not place plants or animals inside the chamber.
Poor cleaning or scratching of label plates and/or instrumentation can lead to mistakes and consequent dangers.	Clean instruments and label plates carefully with the appropriate products.
Poor training of personnel.	Request an additional training course from <b>COMINOX</b> .

## TRANSPORTATION AND PACKAGING

During transport, the sterilizer is protected by a cardboard box.

Lifting and transportation are to be carried out by qualified personnel only.

Weights and dimensions of occupied space are provided in the DIMENSIONS chapter and in the Technical specifications table.



*Lifting means should not damage or compromise the operation of the sterilizer. The packed sterilizer must be lifted after being fitted onto the special pallet, and only using forklifts.*

Transportation of the sterilizer, particularly by road, must be conducted using means of transportation that can adequately protect the components (especially electronic components) against violent knocks, humidity, vibrations, and so on.



*The sterilizer may be transported only after fully emptying the clean water tank **10** and the waste water recovery tank **11**.*

**COMINOX** does not accept sterilizers for repair if they have full tanks (see Chap. MANUALLY DRAIN TANKS).

Very heavy items or equipment (heavier than 30 kg) must only be moved or lifted using appropriate lifting devices.

At least two people are required for manual lifting, using the special *lifting straps 23* provided and following the correct procedures as specified by current regulations.



*Never lift or move the sterilizer using the door **16** or holding onto other plastic parts.*

### Unpacking and cleaning the components



*Remember that packaging (wood, nails, paper, cellophane, metal staples, adhesive tape, straps, ropes, etc.) can cut and/or injure if not carefully handled.*

They should be removed using appropriate means and not left within reach of unauthorized persons (especially children). The same applies to any device used to remove packaging (scissors, hammers, tongs, knives, etc.).

Packaging components must be removed and disposed of according to the regulations in force in each country.

You are advised to retain the packaging and the *lifting straps 23* for possible moves in the future.

When opening the package, the first thing to do is check all the pieces and parts of the sterilizer. Check that all components required are present and in perfect condition (see GENERAL SUPPLY CONDITIONS).

Remove the supplied parts by opening the *door 16* (see OPERATION).



*In the event of defects or wear and tear, immediately interrupt any operation, contact the shipping or forwarding agent, and promptly inform **COMINOX**.*

The load support system and the external surface of the sterilizer are sometimes protected by a plastic film: it must be removed before using the sterilizer.

### Storage

If the sterilizer will not be used immediately or if it will be removed from the installation site, it must be stored in a dry, protected location.

If you wish to cover the sterilizer with plastic sheeting, you must first insert silica gel or other desiccant systems inside the packaging.



*Never place any objects on top of the sterilizer packaging, especially with loads concentrated on protruding feet or screws.*

Ideal ambient storage conditions are:

- **temperature with empty systems - 25°C + 40°C.**
- **maximum relative humidity 90%.**

# INSTALLATION

## GENERAL CONDITIONS

Installation of the sterilizer is to be carried out according to Customer requirements and those of the site where the sterilizer is to be installed. Therefore, it is important that the Customer promptly informs **COMINOX** of any special situations (such as ambient conditions, size, or built-in limits).



*The operation must be performed by trained, qualified personnel only: it is important to comply with the specifications in this manual and follow the technical diagrams and documents.*

In general, it is necessary to:

- check that any ambient conditions are acceptable (explosion risk, excessive ventilation, or high humidity).
- check that the unit is not exposed to any adverse weather conditions, such as sun, rain, wind, etc.
- check that the power supply complies with the specifications provided on the label plates affixed to the sterilizer.
- check that the power supply is properly grounded.



*Avoid any electro-magnetic interference that could affect the proper operation of electronic equipment, leading to consequent dangers.*

## Arrangement

The sterilizer should be installed in a laboratory or medical or dental office where it can be accessed exclusively by **authorized personnel**.

### IT IS NOT BE INSTALLED:

- near sources of heat.
- in rooms where volatile explosive substances are kept.
- under or above any live equipment.
- in unsuitable built-in units.
- without the fitted adjustable feet.
- in domestic environments accessible to untrained personnel.
- on surfaces that are flammable, soft, unstable, or have wheels.

Position the unit in the area where it will be installed, on a sturdy, perfectly horizontal surface.

When installing the unit for the first time (and whenever it is removed from its original installation location), follow the procedure indicated below:

- position the sterilizer where it will be installed and do not move it thereafter.
- open the *door 16* and empty the *chamber 09*.
- remove the *coil covering grid 19*, loosening the corresponding screw.



**WARNING** *the door 16 cannot be opened if the unit is switched off (see OPERATION).*

- remove the *tray support 08*.
- remove the *waste filter 20* and place the supplied *level testing pipe 27* in the hole. The filter is located in the middle at the bottom of the chamber.
- get the *metering funnel 05*, insert the plug provided, and fill it based on the model with:
  - SterilClave 18 = 60 cc.**
  - SterilClave 24 = 80 cc.**
- use ONLY distilled or demineralized water (see Water supply table).
- slowly pour the contents of the funnel into the bottom of the chamber.
- the water cannot descend through the drainage hole, so it will flow toward the outside of the chamber. The water must not spill out of the chamber. If the levelling is correct, when the full quantity of water measured is poured into the chamber, it must touch the *chamber probe 21*.
- if the levelling is not correct, loosen the clamping nuts and adjust the *adjustable feet 22*.
- raise the feet if the water tends to exit. Otherwise, lower them.
- after levelling, tighten the clamping nuts on the *adjustable feet 22*, remove the water, and dry the chamber with a cloth.



**WARNING: NEVER REMOVE THE FEET COMPLETELY**  
Do not block the space under the sterilizer.

- remove the *level testing pipe 27* and replace the *waste filter 20*.
- insert the *tray support 08* and the *coil covering grid 19*. Fasten with the corresponding screw, paying attention to the *grid seal 28*.

## CONNECTIONS

### Electrical connections

To connect to the power supply, simply plug in the sterilizer by inserting the *power cable 03* plug into a suitable socket (see GENERAL CONDITIONS and the Technical specifications table).

### Water connection

This option comes standard on BHD and can be requested for other models.

This option makes it possible to avoid stopping the unit to fill the *clean water tank 10* and to empty the *waste water recovery tank 11*.

#### 1) Auto water fill

This is an alternative configuration to manually refilling the *clean water tank 10* (see MANUALLY FILL CLEAN WATER TANK).

- A) FROM EXTERNAL CAN** (maximum height differential 1 m): the *auto water fill 29* tube can be connected directly to a can of demineralized or distilled water purchased on the market, or to a can of distilled water produced by a Cominox water demineralization system (Discom).

- B) FROM WATER MAIN:** the *auto water fill 29* tube can be connected directly to a Cominox water demineralization system (Speedy Water or Osmosis).

For both the **A** and **B** configurations, the Self-filling setting must be ON in the Main Settings Menu. Configuration **B** requires installation by a qualified technician. Check that the water quality complies with the water supply table.

## 2) Direct drain

This is an alternative configuration to manually draining the *waste water recovery tank 11* (see MANUALLY DRAIN TANKS).

Connect the tube fitted with a male quick connector to the female fitting on the *direct drain 30* after placing the other end of the tube at a suitable drain.

Once the pipe is connected, any water in the *waste water recovery tank 11* will start to drain.

**!** **WARNING:** liquid temperature can reach 80°C, and the liquid may be contaminated. The liquid should be disposed of according to the legislation in force.

## Water supply table

	<b>Water supply</b>
Residue from evaporation	≤10 mg/l
Silicon Dioxide SiO <sub>2</sub>	≤1 mg/l
Iron	≤0.2 mg/l
Cadmium	≤0.005 mg/l
Lead	≤0.05 mg/l
Remaining heavy metals excluding iron, cadmium, lead	≤0.1 mg/l
Chlorides	≤2 mg/l
Phosphates	≤0.5 mg/l
Conductivity (at 20°C)	≤15 µS/cm
Acidity value pH	From 5 to 7
Appearance	Colorless, clean, without sediment
Hardness	≤0.02 mmol/l



## MANUALLY FILL CLEAN WATER TANK

If Self-filling option is not available or not selected (see WATER CONNECTION), fill the tank manually.

Unscrew and remove the cap from the *filler 14*, insert the *metering funnel 05* provided, and pour in distilled or suitably demineralised water (see Water supply table and Technical specifications table for the quantity).

If you fill the sterilizer when it is switched on and in STAND BY mode, the MIN WATER LEVEL and MAX WATER LEVEL indications on the display will allow you to check the level. An audible signal lasting three seconds will go off when the MAX WATER LEVEL indication appears, indicating that the tank is full.

Top up with water whenever the MIN WATER LEVEL indicator appears on the display.

For maximum operating time before refilling, fill the tank completely until the MAX WATER LEVEL indicator appears, and completely empty the *waste water recovery tank 11* (see MANUALLY DRAIN TANKS).

## MANUALLY DRAIN TANKS

When there is no DIRECT DRAIN (see WATER CONNECTION) or it is not connected, the *waste water recovery tank 11* must be drained manually whenever the DRAIN WASTE WATER indicator appears on the display (see SIGNALS AND ALARMS).

Connect the *waste pipe 02* provided to the *waste water tap 25* after placing a container of sufficient size under the other end (see Technical specifications table) to collect the water.

Open the tap to allow any water left in the *waste water recovery tank 11* to drain.



**WARNING:** *the temperature of the liquid can reach 80°C and the liquid may be contaminated. The liquid should be disposed of according to the legislation in force.*

For maximum operating time before refilling, empty the tank completely and completely fill the *clean water tank 10* until the MAX WATER LEVEL indicator appears (see MANUALLY FILL CLEAN WATER TANK).

The *clean water drainage tap 24* is used to empty the *clean water tank 10* for maintenance or transport (see Chap. TRANSPORTATION and MAINTENANCE) and it is only used under these conditions.

## PREPARING FOR BUILT-IN INSTALLATION

If the sterilizer will be built into a furniture item or another storage rack, you must follow ALL the instructions provided for normal installation, plus you must:

- comply with the built-in distances (see Chap. DIMENSIONS).
- provide adequate ventilation for the components.
- take into account *heat emissions* produced by the sterilizer (see Technical specifications table).
- allow for the *door 16* to open.
- allow for routine maintenance.
- prevent damage to the sterilizer.
- provide for the room necessary for installing the accessories for a water supply fitting.

## OPERATION

### SWITCH-ON

To turn on the sterilizer, press the *main switch 13* located behind the *door 18*. The sterilizer switches to OFF:

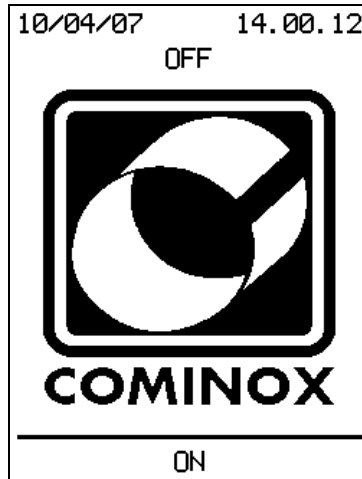

Press ON using one of the four multi-function buttons below the display; the screen displays a welcome message, and the sterilizer switches to STAND BY mode. If the sterilizer is equipped with a *SterilCard 06* (optional, standard on BHD models), pressing ON will display a request for the *SterilCard 06* to be inserted:

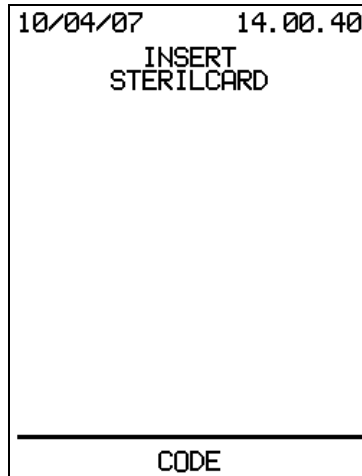

The *SterilCard 06* should be inserted with the chip facing upward and forward. When the card is inserted, the sterilizer will beep. If the *SterilCard 06* cannot be read, the CODE button will initiate an emergency procedure that allows the user to operate the sterilizer.

Pressing CODE will display the message:

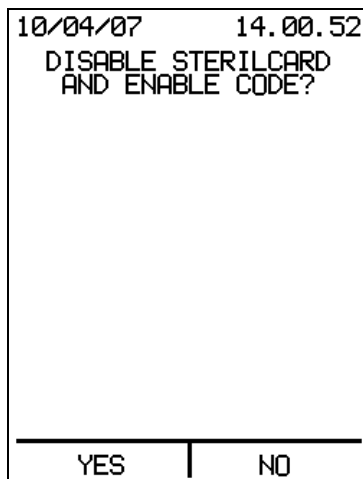

Pressing YES causes the sterilizer to deactivate the *SterilCard 06* for the next usage section, and it proceeds to another screen that asks for a security code (set to 1 by default):

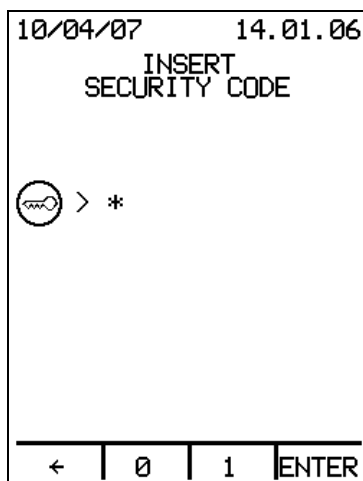

Pressing the ← key deletes the last number entered, or, if no numbers are shown on the display, it returns to OFF mode.

The CODE button is only present when the sterilizer is switched on from the *main switch 13*. Thereafter the "INSERT STERILCARD" screen will not feature the CODE button:

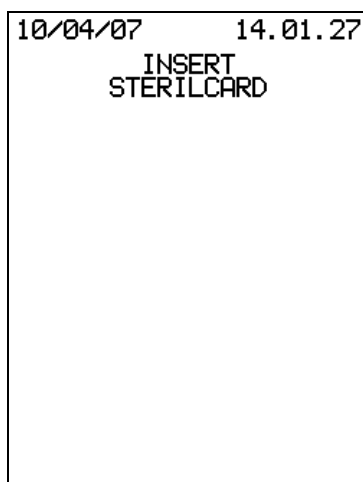

After the *SterilCard 06* or Security Code is inserted, the sterilizer displays a WELCOME message and switches to STAND BY mode.

## STAND BY

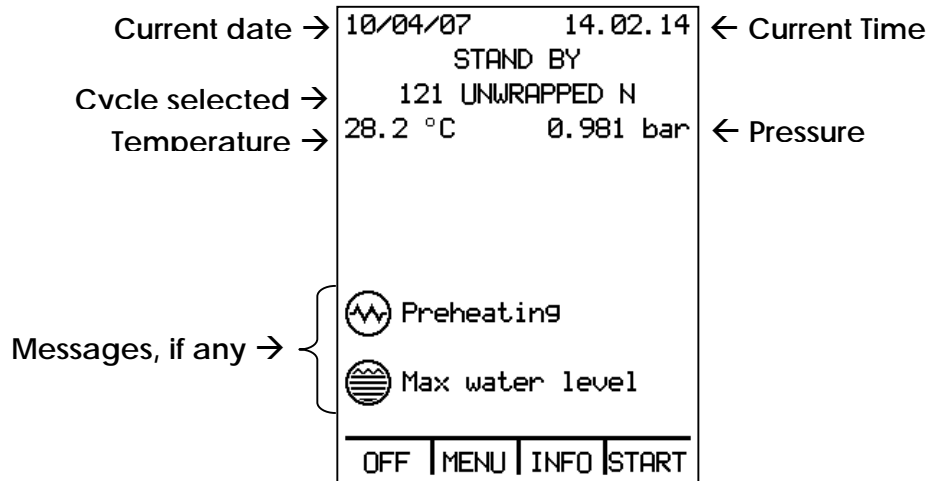

The display will show the current date and time, the cycle selected, the temperature and pressure of the sterilization chamber, and any messages:



**Mainten. schedule:** indicates that a scheduled maintenance procedure is needed for one or more components. Contact a technical service center.



**Programmed start:** indicates that a start has been programmed for the cycle on the display. The cycle will begin automatically at the date and time displayed.



**Check water qual.:** activates when the *auto water fill 29* is set. Indicates that the conductivity value of the water introduced has exceeded the optimum level, but is still acceptable; the sterilizer allows a cycle to begin, but it is advisable to follow the instructions provided for the WATER QUALITY INSUFFICIENT ALARM (see ALARMS).



**Min water level:** minimum level reached in the *clean water tank 10*.



**Preheating:** sterilizer heating. Indicates that the exterior coil is working. Preheating is activated when the *door 16* is closed and the handle clicks.



**Wait door unlock:** activates at the end of a cycle or directly after turning the sterilizer on, and indicates that the *door 16* is opening. To access the *chamber 09*, wait until the indicator disappears, without attempting to open the door.



**Cooling pause:** indicates that the temperature in the *chamber 09* is not suitable to start or continue a cycle.



**Max water level:** maximum level *clean water tank 10*.



**Drain waste water:** indicates that the *waste water recovery tank 11* is full. Empty the tank (see MANUALLY DRAIN TANKS). If the *direct drain 30* is installed (see CONNECTIONS), check that the connection is correct and that the pipe is not bent or clogged.

## MENU

From STAND BY, using the four multi-function buttons, you can navigate the menu and program the various SterilClave functions.

When you select MENU from STAND BY, the options available are:

1. Cycle
2. Main settings
3. Advanced tools
4. Cycle records
5. Maintenance



Use the ↑↓ arrows to scroll through the list until the item you want is highlighted. Press ENTER to access the menu selected.

## 1. Cycle Menu

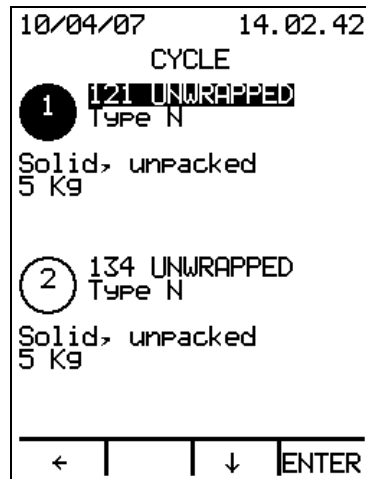

Use the ↑↓ arrows to highlight the various cycles:

1. 121 UNWRAPPED: cycle at 121°C for delicate solid products, unpackaged only
2. 134 UNWRAPPED: cycle at 134°C for solid products, unpackaged only
3. 134 WRAPPED: cycle at 134°C for solid products, packaged or unpackaged
4. 121 HOLLOW/POROUS: cycle at 121°C, for delicate porous and hollow products, packaged or unpackaged
5. 134 HOLLOW/POROUS: cycle at 134°C, for solid, porous, and hollow products, packaged or unpackaged
6. 134 PRION: cycle at 134°C, for solid, porous, and hollow products that have come in contact with BSE infective agents, packaged or unpackaged
7. SPECIAL USER: user-programmable cycle
8. BOWIE & DICK TEST;
9. VACUUM TEST

For each cycle, the display shows the type of cycle (according to standard EN 13060), the loads allowed, the maximum weight, and the type of packaging.

Press ENTER to return to STAND BY, where you can run the cycle you have just selected by pressing START.

## 2. Main Settings Menu

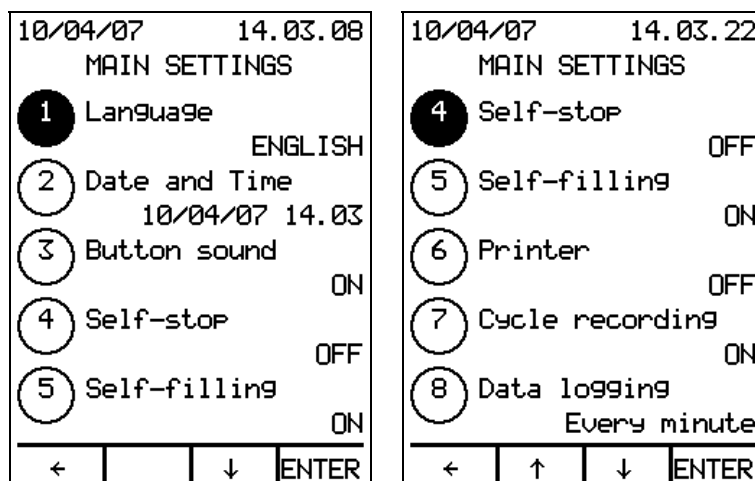

The main settings that can be changed are:

1. Language
2. Date and Time
3. Button sound
4. Self-stop
5. Self-filling
6. Printer
7. Cycle recording
8. Data logging

Use the ↑↓ arrows to scroll through the list of settings; press ENTER to change the value of the setting selected.

Press the ← key to move back a screen without changing the setting values.

## 2.1 Language

Press ENTER to show the language:



Use the ↑↓ arrows to change the language, and press ENTER to confirm the selection. Press the ← key to exit without changing the setting value.

## 2.2 Date and Time

Press ENTER to show the day. Use the ↑↓ arrows to change the value. Press ENTER to confirm the information and move on to the next setting.

Press the ← key to exit without changing the setting value.

## 2.3 Button Sound

Press ENTER to show the value of the Button Sound setting (ON/OFF). Use the ↑↓ arrows to change the setting. Press ENTER to confirm the information, or press ← to exit without changing the value of the setting.

## 2.4 Self-stop

Press ENTER to show the Self-stop value, which can be set using the ↑↓ arrows, to 30 minutes, 1 hour, 2 hours, 3 hours or OFF. If the Self-stop is set and no button is pressed to select a time, the sterilizer will automatically turn OFF, thus reducing energy consumption to a minimum.

Press ENTER to confirm the information, or press ← to exit without changing the value of the setting.

### 2.5 Self-filling

This item is only available if the *auto water fill 29* is installed (optional; standard on BHD models).

Press ENTER to show the value of the automatic fill setting (ON/OFF). Change the setting with the ↑↓ arrows if required. Press ENTER to confirm the information, or press ← to exit without changing the value of the setting.

### 2.6 Printer

This item is only available if the sterilizer is equipped with a *printer 26* (optional).

Press ENTER to show the value of the Printer setting (OFF, 1 copy, 2 copies, 3 copies). Use the ↑↓ arrows to set the printer and the number of copies. Press ENTER to confirm the information, or press ← to exit without changing the value of the setting.

### 2.7 Cycle Recording

This item is only available if the sterilizer is equipped with a *SterilCard 06* (optional, standard on BHD models).

Press ENTER to show the value of the Cycle Recording setting (ON/OFF); use the ↑↓ arrows to change the value if required. Press ENTER to confirm the information, or press ← to exit without changing the value of the setting.

### 2.8 Data Logging

Press ENTER to show the value of the Data logging setting.

Use the ↑↓ arrows to set the data logging mode – Each Minute or Phase Change – a mode that is valid both for printing the data and for recording the cycles on a *SterilCard 06* or in the internal memory of the sterilizer.

Press ENTER to confirm the information, or press ← to exit without changing the value of the setting.

## 3. Advanced Tools Menu

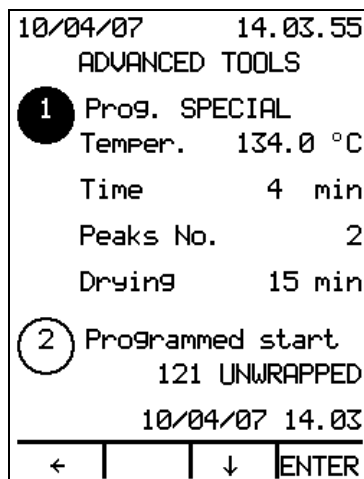

This menu gives you access to the Advanced Tools:

1. Prog. SPECIAL
2. Programmed start
3. Hollow loads
4. Change sec. code
5. SterilCard option

Use the ↑↓ arrows to scroll through the list of advanced tools and press ENTER to access the item selected.

Press the ← key to exit.



### 3.1 Prog. SPECIAL

To access this item, you need a security code.

However, if the sterilizer is equipped with a *SterilCard 06* (optional, standard on BHD models), no code is required: the item is only available if the *SterilCard 06* inserted is an Administrator *SterilCard*, or if the User *SterilCard 06* is authorized to access the programming of the SPECIAL cycle.

10/04/07	14.04.36	
ADVANCED TOOLS		
1	Prog. SPECIAL	
	Temper. 134.0 °C	
	Time 4 min	
	Peaks No. 2	
	Drying 15 min	
2	Programmed start	
	121 UNWRAPPED	
	10/04/07 14.04	
←	↓	ENTER

Press ENTER to change the values of the SPECIAL cycle parameters. In particular:

- the sterilization temperature (from 117°C to 134°C).
- the sterilization duration. The maximum value is 30 minutes, and the minimum depends on the temperature setting.
- the number of peaks in the vacuum pulse phase (from 0 to 3).
- the drying duration (from 0 to 30 minutes).

Use the ↑↓ arrows to change the value of the parameter, and press ENTER again to confirm the input and move to the next parameter.

Press the ← button to exit without changing the value of the parameters.

The SPECIAL cycle is an alternative to the standard cycles listed in the Table of cycles/sterilizable material, and can be programmed based on specific sterilization needs for special instruments or other loads. The SPECIAL cycle is not covered by the technical requirements of the EN 13060 standard with which the **COMINOX** autoclaves comply: for this reason, only qualified laboratory personnel are permitted to use the SPECIAL cycle. These people, authorized by the Administrator, must execute a confirmation (for example, in line with standard EN 554) for each special programmed cycle, with a specific reference load.

### 3.2 Programmed start

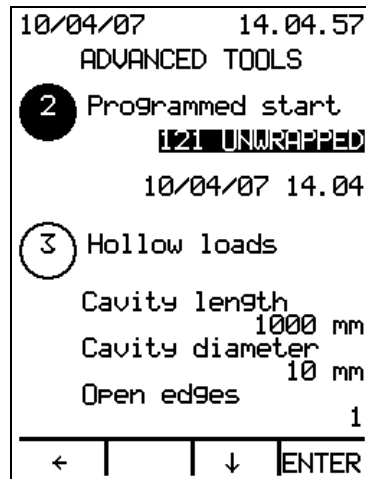

Press ENTER to select the cycle to run. Use the ↑↓ arrows to select from among:

- 121 UNWRAPPED
- 134 UNWRAPPED
- 134 WRAPPED
- 121 HOLL./POROUS
- 134 HOLL./POROUS
- 134 PRION
- SPECIAL USER
- BOWIE & DICK TEST
- VACUUM TEST
- VACUUM+B&D TEST

The VACUUM+B&D TEST cycle calls for the Vacuum Test followed by the Bowie & Dick Test, with a 5-minute pause between the two cycles and a preheating period to prepare the sterilizer for the Bowie&Dick Test.

Press the ← key to exit without programming any cycle to begin.

After you have selected the cycle, press ENTER to view the day. This value can be changed using the ↑↓ arrows. Press ENTER to confirm the information and move on to the next setting.

Once you have set the current date and time, check that the *door 16* is closed and the *clean water tank 10* is full, and check whether the *waste water recovery tank 11* needs to be emptied. If any one of these operations has not been performed, the sterilizer will indicate this with a message on the display.

Press ENTER to return to STAND BY mode. The display will indicate which start is programmed:

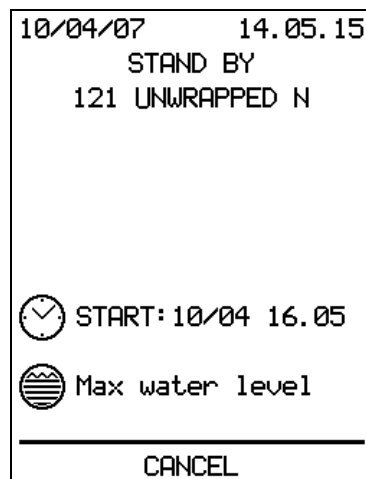

At the set time, the sterilizer will automatically run the chosen cycle.  
 Press CANCEL to cancel the programmed start and return to STAND BY.

### 3.3 Hollow Loads

This function allows for automatic recognition of the load type (HOLLOW A, HOLLOW B, or SOLID), entering the length and diameter of the cavity (in millimetres) and the number of open ends.

Press ENTER to display the value of the first item:

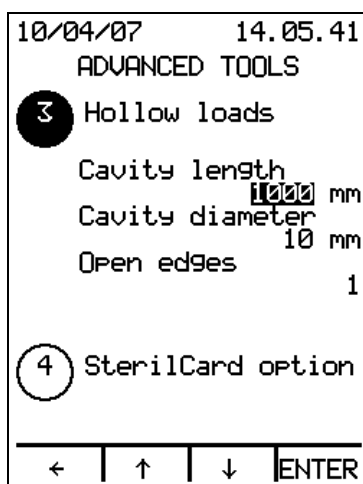

Use the ↑↓ arrows to change this value. Press ENTER to confirm the information and move to the next item. After you enter the number of open ends and press ENTER, the type of load will appear on the display:

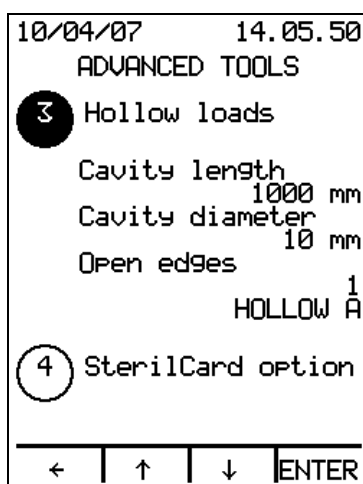

Press the ← button to exit.

#### 3.4a Change sec. Code

If the sterilizer is equipped with a *SterilCard 06* this item is not available.

This function allows the user to change the sterilizer access code.

Pressing ENTER takes you to a new screen that asks you to enter the current security code.

Press ENTER to move on to entry of the new binary security code (maximum 6 digits):

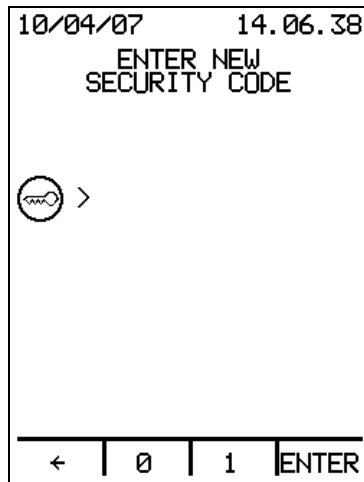

Press the ← button to delete the last number entered, or, if there are no numbers on the display, to exit without changing the code.

Once you have finished your entry, press ENTER to bring up the screen to confirm the code you have just entered. Enter the new code, and press ENTER to save it. If the *printer 26* (optional) is installed, you can print this new security code.

Press the ← button to exit without changing the security code.

### 3.4b SterilCard Option

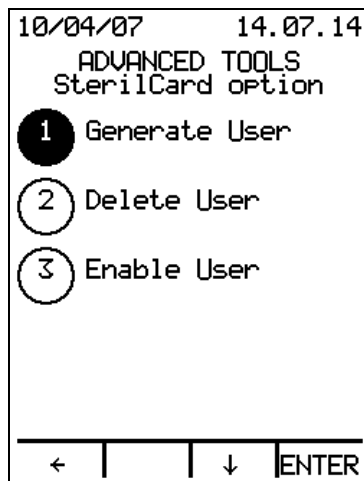

This item is only present if the sterilizer is equipped with a *SterilCard 06* (optional, standard on BHD models) and if the *SterilCard 06* inserted is an Administrator SterilCard.

There are three *SterilCard 06* management functions:

1. Generate User
2. Delete User
3. Enable User

#### 3.4b.1 Create User

Press ENTER to access the screen for entering the name of the new user:

10/04/07		14.07.55					
ENTER NEW USER NAME							
 > COMINOX							
DELETE		A	B	C	D		
E	F	G	H	I	J	K	L
M	N	O	P	Q	R	S	T
U	V	W	X	Y	Z	END	
←		<	>	ENTER			

Using the <> keys, scroll through the keyboard to select a letter. Press ENTER to confirm each letter. Once you have finished composing the name in this way, select END and press ENTER to confirm the name of the user and move to the next screen to choose the cycles:

10/04/07		14.08.10	
SELECT CYCLE			
121	UNWRAPPED	N	<input checked="" type="checkbox"/>
134	UNWRAPPED	N	<input type="checkbox"/>
134	WRAPPED	S1	ON
121	HOLL./POROUS	B	ON
134	HOLL./POROUS	B	ON
134	PRIONS	B	ON
SPECIAL USER			ON
←		↓	ENTER

The ON/OFF value for the first cycle is displayed and can be changed using the arrows ↑↓. Cycles set to ON will be entered in the new user profile. Press ENTER to confirm the selection and move on to the next cycle. If the SPECIAL cycle is set to ON, you will be shown the screen for setting the values for the SPECIAL cycle parameters:

10/04/07		14.08.25	
SET UP CYCLE SPECIAL USER			
Temper.		134.0	°C
Time		4	min
Peaks No.		2	
Drying		15	min
User set up		ON	
←		↓	ENTER

If user programming is ON, the new user will be allowed to change the parameters of the SPECIAL cycle. If it is set to OFF, the new user will be allowed to launch the SPECIAL cycle, but will not be allowed to change its parameters. Once the new profile is complete, the sterilizer will request that the new user *SterilCard 06* be inserted for programming:

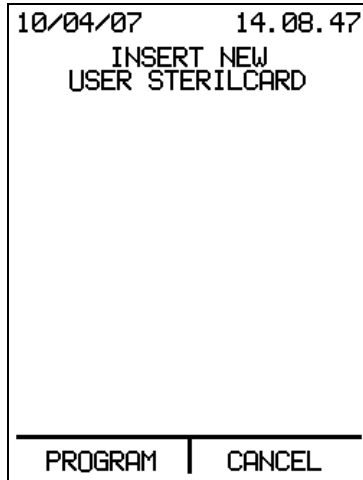

Press CANCEL to return to the SterilCard Option menu. Press PROGRAM to save the profile just created on the *SterilCard 06* inserted in the sterilizer.

If the operation finishes successfully, the following message will appear:



Otherwise, if errors occurred, the screen will read:

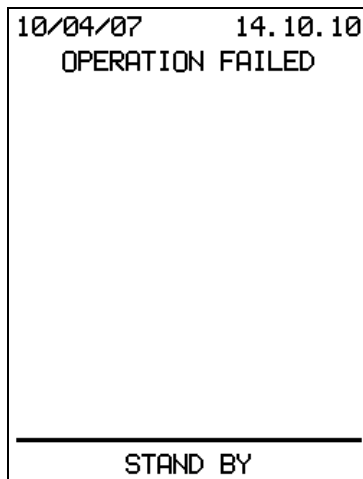

In both cases, press one of the 4 multi-function buttons to return to STAND BY.

If the User *SterilCard 06* that was inserted has already been programmed, the following message appears:



Press REWRITE to overwrite the new profile onto the *SterilCard 06* inserted, and then view the results of the operation.

Press CANCEL to return to the SterilCard Option menu.

Only User *SterilCards 06* can be programmed. If an Administrator *SterilCard 06* is inserted, the screen will read "STERILCARD LEVEL NOT COMPLYING", and a User *SterilCard 06* must be inserted to proceed with programming.

### 3.4b.2 Delete User

Press ENTER. The sterilizer will ask you to insert the User *SterilCard 06* to be deleted:

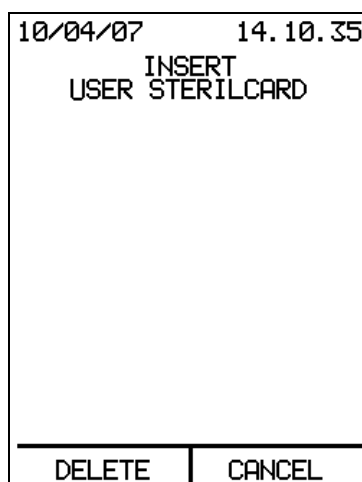

Press CANCEL to return to the SterilCard Option menu.

Press DELETE to remove the profile on the *SterilCard 06* inserted in the sterilizer, and the cycles and maintenance records along with it. If the operation finished successfully, the message "Operation ended with success" will appear. If there were errors, the display will read "Operation failed". In both cases, pressing one of the 4 multi-function buttons will return the sterilizer to STAND BY mode.

You can delete just one User *SterilCard 06* enabled for the current sterilizer.

If the *SterilCard 06* inserted is an Administrator level card, the following message appears: "STERILCARD LEVEL NOT COMPLYING". If the card is not enabled, the screen will read: "STERILCARD NOT ENABLED"

### 3.4b.3 Enable User

Press ENTER to display the request to enter the User *SterilCard 06* that you want to enable:

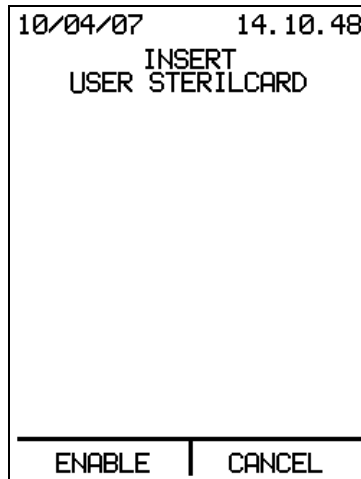

Press CANCEL to return to the SterilCard Option menu.

Press ENABLE, and the User *SterilCard 06* inserted will be enabled to use the current serial number. If the operation finished successfully, the message "Operation ended with success" will appear. If there were errors, the display will read "Operation failed". In both cases, pressing one of the 4 multi-function buttons will return the sterilizer to STAND BY mode.

Each User *SterilCard 06* can be enabled to use 10 different serial numbers. If a User *SterilCard 06* is already enabled for 10 serial numbers and you want to enable a new serial number, the sterilizer will ask you to delete one number from the list to make room for the new number and complete the operation:

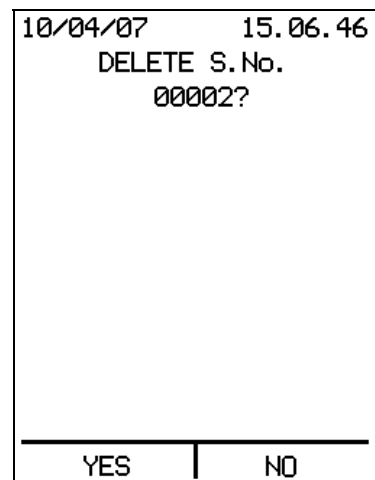
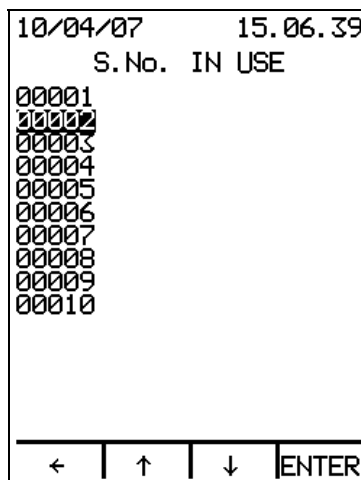
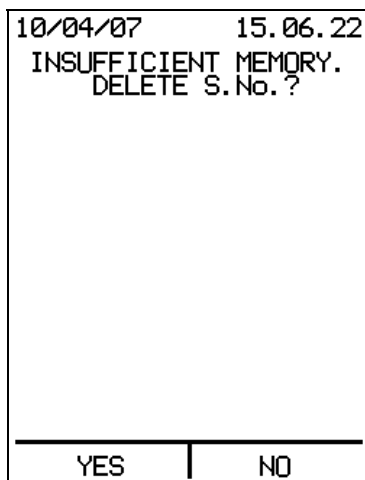

After you select a serial number from the list and press ENTER, the sterilizer will ask you to confirm the deletion. Choose YES to delete the serial number from the list. Then enable the User *SterilCard 06* for the current serial number.



It is only possible to enable User *SterilCards 06* that are already programmed. If the *SterilCard 06* inserted is an Administrator level card, the following message appears: "STERILCARD LEVEL NOT COMPLYING". If it is empty, it will read: "STERILCARD NOT PROGRAMMED".

#### 4. Cycle Records Menu

```

10/04/07      14.12.34
CYCLE RECORDS
1 121 UNWRAPPED
  Type N
  S.No.      00011
  10/04/07  10.19.29

2 134 HOLL./POROUS
  Type N
  S.No.      00011
  10/04/07  09.19.21

3 121 UNWRAPPED
  Type N
  S.No.      00011
  10/04/07  07.19.13

← |         | ↓ | ENTER

```

After you press ENTER, the list of cycles saved on the *SterilCard 06* or in the internal memory (for sterilizers not equipped with *SterilCard 06*) will appear in chronological order, starting with the most recent.

Use the ↑↓ arrows to scroll through the list, and press ENTER to access the cycle selected:

```

10/04/07      14.12.52
CYCLE RECORDS
121 UNWRAPPED N
Serial number      00011
User connected     COMINOX
Cycle              241
Date               10/04/07
Start time         10.19.29

← | EVENT | PRINT | PLOT

```

For each cycle the following are displayed: the serial number, the user who launched it, the cycle number, and the date and time it was initiated.

Press EVENT to access a screen that describes the phases of the cycle. If the cycle was interrupted by an alarm, a description of the alarm will be shown with the values for cycle duration, temperature, and pressure when the alarm was triggered.

PRINT is only enabled if the sterilizer features a *printer 26* (optional). It will print the parameters of the cycle in the mode in which the cycle was saved. When printing, the screen will read PRINTING; when complete, the sterilizer returns to the cycle screen.

Press PLOT to access the absolute pressure diagram for the cycle selected.

Press ← to return to the Cycle Records Menu.

## 5. Maintenance Menu

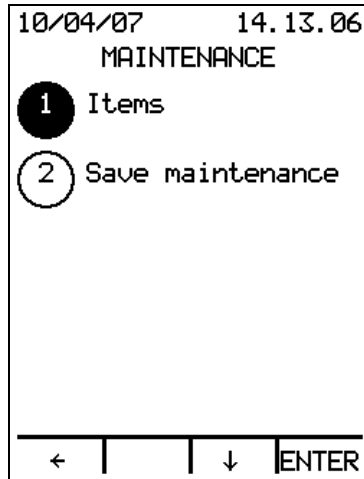

Two options are available under this menu:

1. Items
2. Save Maintenance

### 5.1 Items

Press ENTER to view the list of components subject to scheduled maintenance:

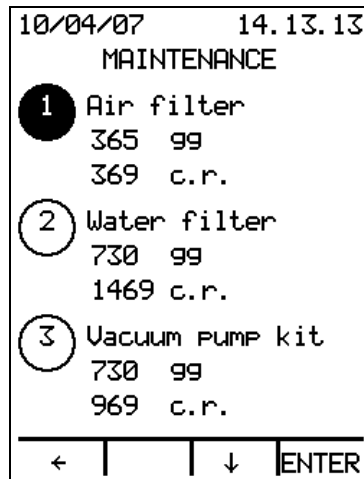

For each component, the remaining days and cycles are shown, along with the last three replacements, the date of the operations, and the total number of cycles at that point.

Use the ↑↓ arrows to scroll through the entire list. For some items (Air filter and Door gasket), the ENTER key is activated to record a replacement. Press ENTER to display:

10/04/07	14.13.30
MAINTENANCE	
REPLACED ITEM Air filter?	
YES	NO

Pressing YES will record the replacement; pressing NO will take you back to the list of items.

Only authorized technicians can replace and record the other items.

## 5.2 Save Maintenance

Press ENTER to access this screen:

10/04/07	14.13.45
SAVE MAINTENANCE ON STERILCARD?	
YES	NO

Press NO to return to the Maintenance Menu.

Press YES to save the maintenance record on the *SterilCard 06* inserted. This record is overwritten each time.

The record is only saved if the *SterilCard 06* inserted is programmed and activated.

## INFORMATION in STAND BY

When in STAND BY mode, pressing INFO will bring up a screen containing information about the sterilizer:

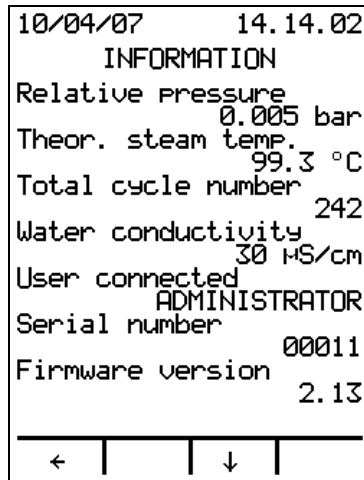

Use the ↑↓ arrows to scroll through the information and view:

- Relative pressure
- Theoretical steam temperature
- Total number of cycles
- Water conductivity of last load (only if automatic fill is available and enabled)
- User connected (only if the sterilizer has a *SterilCard 06*)
- Serial number
- Firmware version
- Programming file

Press the ← key to return to STAND BY.

## STARTING the CYCLE

From STAND BY, press START to run the cycle shown on the display.  
If the *door 16* is not locked, SterilClave will display:

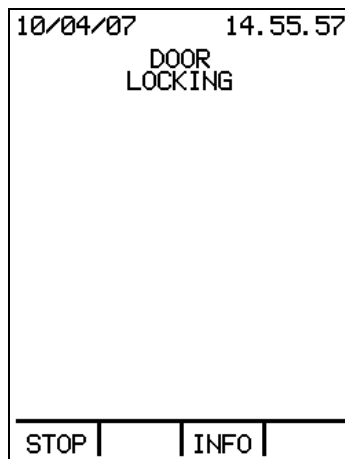

Pressing INFO you can view all the information of the STAND BY mode, pressing STOP you stop the door locking and go back to STAND BY.

As soon as the *door 16* is locked, the cycle will start:

10/04/07	14.57.59
134 HOLL./POROUS B	
PREVACUUM	
21.6 °C	0.671 bar
Cycle duration	00.41
 Door locked	
STOP	EVENT   INFO   PLOT

10/04/07	15.20.48
134 HOLL./POROUS B	
STERILIZATION	
135.1 °C	3.120 bar
Cycle duration	23.30
Time remaining	03.14
 Door locked	
STOP	EVENT   INFO   PLOT

10/04/07	15.50.42
134 HOLL./POROUS B	
CYCLE END	
117.4 °C	0.990 bar
Cycle duration	48.58
 Cycle completed	
STOP	EVENT   INFO   PLOT

During the cycle, the display will show:

- The current date and time
- The cycle in progress
- The phase of the cycle in progress
- The temperature in the sterilization chamber
- The pressure in the sterilization chamber
- The cycle duration
- The end-phase time (for sterilization and drying phases)
- The “Door locked” indicator
- A “Cooling pause” message, if applicable
- The “Cycle completed” message at the end of the cycle

During the cycle, the multi-function buttons correspond to: STOP/EVENT/INFO/PLOT.

### STOP the CYCLE

The STOP button will halt the cycle in progress.

 *You can interrupt the cycle at any time by pressing STOP, but you are advised to stop the cycle only in an emergency.*

If a cycle is interrupted with a load of packaged instruments, even when the sterilization phase is complete, sterility is not guaranteed because the load has not dried. Unless they are reused immediately, the instruments should be run through another sterilization cycle. When the STOP button is pressed, the sterilizer shows a MANUAL STOP ALARM, describing the cycle and the phase in which the alarm was triggered. The alarm can be silenced by pressing any one of the four multi-function buttons:

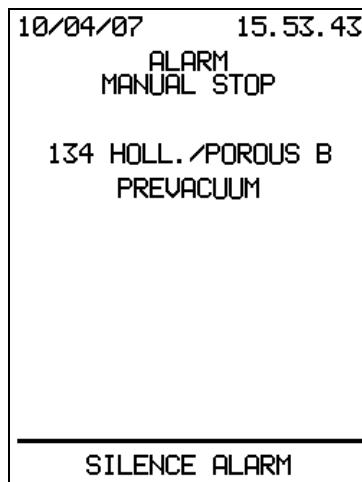

The sterilizer will then switch to STAND BY mode.



*When the STOP button is pressed, if the pressure inside the chamber **09** is greater than 0.2 bar, the door locking device will still be engaged. The display will show the message "Wait door unlock", and the door cannot be opened.*

Wait for the pressure to return to 0 bar, checking the relative pressure by pressing the INFO button, and then open the *door 16*.



**WARNING!** *Beware of the steam that exits from the door, and do not touch the load, its support system, or any hot surface unless you are wearing suitable protective gloves or using the special tray handle 01.*

Pull out the load and, if it is packaged, check that the packaging has not been damaged (e.g.: open seals). Material in damaged packages must be repackaged and run through a new sterilization cycle.

If installed and enabled, the *printer 26* (optional) produces a full report on the cycle conducted.

When the cycle is complete, press STOP to return to STAND BY, or, only for cycles that end with drying, open the *door 16*.

### EVENTS in the CYCLE

Press EVENT to access the cycle events screen:

10/04/07	15.51.08
134 HOLL./POROUS B	
EVENTS 	
START	14.57.18
PREVACUUM	00.00
22.5 °C	0.985 bar
STEAM PEAK 1	03.32
26.6 °C	0.148 bar
VACUUM PULSE 1	10.48
132.4 °C	3.100 bar
STOP	↓ ←

10/04/07	15.51.32
134 HOLL./POROUS B	
EVENTS 	
STEAM PEAK 2	13.00
67.3 °C	0.200 bar
VACUUM PULSE 2	16.34
134.4 °C	3.100 bar
PRESSURIZATION	18.51
71.5 °C	0.204 bar
STERILIZATION	22.44
134.6 °C	3.089 bar
STOP	↑ ↓ ←

10/04/07	15.51.56
134 HOLL./POROUS B	
EVENTS 	
STERILIZATION	22.44
134.6 °C	3.089 bar
Temperature	
134.6 °C	135.4 °C
Pressure	
3.079 bar	3.152 bar
Theor. steam temp.	
134.5 °C	135.3 °C
STOP	↑ ↓ ←

10/04/07	15.52.08
134 HOLL./POROUS B	
EVENTS 	
DRYING	28.52
72.6 °C	0.200 bar
CYCLE END	48.58
120.4 °C	0.864 bar
STOP	↑ ←

The display will show information about the phases of the cycle in progress: the phase name, the time the phase began, the temperature, and the pressure of the sterilization chamber at the beginning of the phase. For the sterilization phase, the display also shows the minimum and maximum values of the temperature, pressure, and theoretical steam temperature.

Use the ↑↓ arrows to scroll through the full list, or press the ← button to exit. Press STOP to interrupt the cycle.

The upper part of the display shows the icons corresponding to the Door Locked indicator and the Cycle Completed indicator when the cycle ends.

### INFORMATION about the CYCLE

Press INFO to access the screen containing information about the cycle in progress:

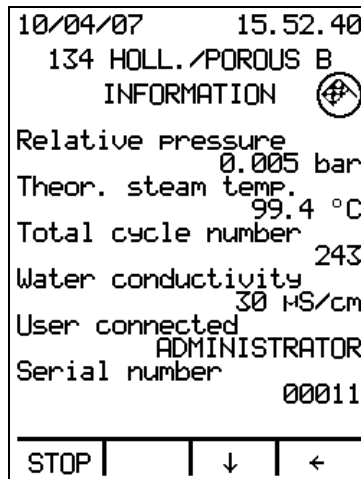

Use the ↑↓ arrows to scroll through the information and view:

- Relative pressure
- Theoretical steam temperature
- Total number of cycles
- Water conductivity of last load (only if automatic fill is available and enabled)
- User connected (only if the sterilizer has a *SterilCard 06*)
- Serial number
- Firmware version
- Programming file

Use the ↑↓ arrows to scroll through the full list, or press ← to exit. Press STOP to interrupt the cycle.

The upper part of the display shows the icons corresponding to the Door Locked indicator and the Cycle Completed indicator when the cycle ends.

### PLOT of the CYCLE

Pressing PLOT accesses a screen that displays a graph of the pressure of the cycle in progress:

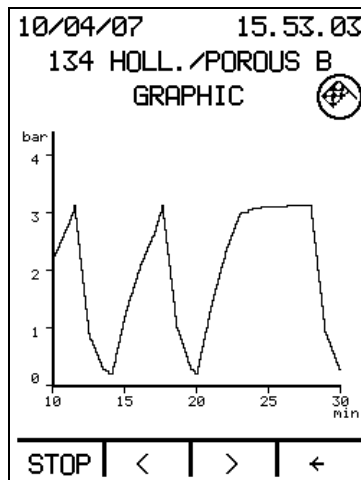

The graph is updated in real time during the cycle, and using the <> keys you can scroll through the entire graph at 5 minute intervals.

Press the button ← to exit. Press STOP to interrupt the cycle.



The upper part of the display shows the icons corresponding to the Door Locked indicator and the Cycle Completed indicator when the cycle ends.

## CONTROL TESTS

All SterilClave models provide two control test cycles: the Bowie & Dick test, and the Vacuum test (air leakage test).

In addition, SterilClave B and BHD models allow tests with hollow A loads, according to EN 13060 (Helix Test).

### Bowie & Dick test

The Bowie & Dick test is used to check the proper steam penetration into porous loads (e.g. gauzes and fabrics) and the efficiency of the air drain system.

The Cominox Bowie & Dick Test Pack consists of a package containing a chemical process indicator, and its even color change ensures that the steam has penetrated properly.



*The Bowie & Dick test must always be run when the sterilizer is HOT, after having run another cycle.*

To run the test correctly, proceed as you would for any other sterilization cycle, but without loading the sterilizer:

- turn the sterilizer on with the *main switch 13*.
- open the *door 16*.
- insert a Cominox Bowie & Dick test package on the lower tray.
- close the *door 16*.
- enter the access code or the *SterilCard 06*.
- press the MENU key from STAND BY, select the Menu Cycle (number 1), and press ENTER.
- use the  $\uparrow\downarrow$  arrows to select the Bowie & Dick test cycle. Press ENTER to return to STAND BY.
- Press START in STAND BY mode and wait for the test to finish: the words CYCLE END and the corresponding icon will appear on the screen.
- press STOP and wait for the sterilizer pressure to return to 0 bar. Then open the *door 16*.
- remove the tray holding the test and check the results of the test according to the manufacturer's instructions.



*The Bowie & Dick test has to be performed according to possible national regulations.*

### Vacuum test

The Vacuum test is used to check the efficacy of the vacuum pump and the full, correct seal of the hydraulic circuit.



*The Vacuum test must be carried out when the unit is COLD (room temperature).*

In order to carry out the test correctly, follow the same procedures as for a normal sterilization cycle, but do not load the sterilizer, and proceed as follows:

- turn the sterilizer on with the *main switch 13*.

- close the *door 16*.
- enter the access code or insert the *SterilCard 06*.
- press MENU from STAND BY mode, select Menu Cycle (number 1) and press ENTER.
- use the ↑↓ arrows to select the Vacuum test cycle and press ENTER to return to STAND BY.
- press START from STAND BY:

```

10/04/07      16.41.11
  VACUUM TEST
  MAINTENANCE

45.5 °C      0.147 bar
Cycle duration 13.39

Time remaining 05.44
Pressure variation
                5 mbar

🔒 Door locked

STOP | EVENT | INFO | PLOT
    
```

- wait for the test to finish, shown on the display by the words "VACUUM TEST CONSISTENT":

```

10/04/07      16.47.26
  VACUUM TEST
  CONSISTENT

48.7 °C      0.977 bar
Cycle duration 19.23

Pressure variation
                13 mbar
Leakage rate
                1.3 mbar/min

STOP | EVENT | INFO | PLOT
    
```

- press STOP, wait for the "Wait door unlock" indication to turn off, and then open the door.

If "REPEAT TEST" appears on the display, the test will be interrupted automatically.

Before repeating the test, open the *door 16*, let the *chamber 09* cool completely, and check that it is perfectly dry.

Whenever you want to run the VACUUM TEST with a chamber temperature above 40°C, the display will show a message reading "Cooling pause", and the cycle will begin only when the temperature drops below 40°C.



**WARNING:** for this reason, selecting the Vacuum test disables preheating when the door is closed and the handle clicks.



If the message "VACUUM TEST NOT CONSISTENT" ever appears after running the vacuum test, contact a TECHNICAL SERVICE CENTER.

## Helix test

The purpose of the test with hollow A load according to standard EN 13060 is to check that steam penetrates correctly into hollow A loads, and to check the efficiency of the air removal system.

This test should be run on B type cycles.

The Cominox Helix test consists of a metal capsule containing a chemical process indicator and a Teflon tube that is 1.5 m long with an internal diameter of 2 mm. The even color change of the chemical indicator ensures that the steam has properly penetrated through the hollow body.

To run the test correctly, proceed as you would for any other sterilization cycle, but without loading the sterilizer:

- turn the sterilizer on with the *main switch 13*.
- open the *door 16*.
- insert the Cominox Helix Test device on the lower tray.
- close the *door 16*.
- enter the access code or insert the *SterilCard 06*.
- press the MENU key from STAND BY, select the Menu Cycle (number 1), and press ENTER.
- use the arrows  $\uparrow\downarrow$  to select the B cycle to be tested. Press ENTER to return to STAND BY.
- press START from STAND BY and wait for the cycle to finish. The words CYCLE END and the corresponding icon will appear on the screen.
- press STOP and wait for the sterilizer pressure to return to 0 bar. Then open the *door 16*.
- remove the tray holding the test and check the results of the test according to the manufacturer's instructions.

## Printer

If installed and enabled (see Main Settings Menu, sec. 2.6), at the end of each cycle, the *printer 26* (optional) will produce a report containing information about the cycle that just ended.

Printing starts when STOP is pressed, or, for cycles that end with drying phases, also when the door is opened.

The printout provides all the information needed to document the cycle:

- the date and time
- the SterilClave model
- the serial number
- the cycle in progress
- the sterilization time
- the sterilization temperature
- the cycle number
- whether or not drying is scheduled
- the description of each phase, with start time and the temperature and pressure values
- in sterilization, the minimum and maximum pressure, temperature, and theoretical steam temperature values will also be printed
- the total cycle duration, with the date and time the cycle ended
- the load
- the operator

The information on time, pressure, and temperature is printed each time the phase changes or after each minute in the cycle has passed, depending on the option selected in the Main Settings Menu for the Data logging parameter (see sec. 2.8).

In the case of an ALARM, the printout will show the code for the alarm that was triggered.

When printing, the screen will read:

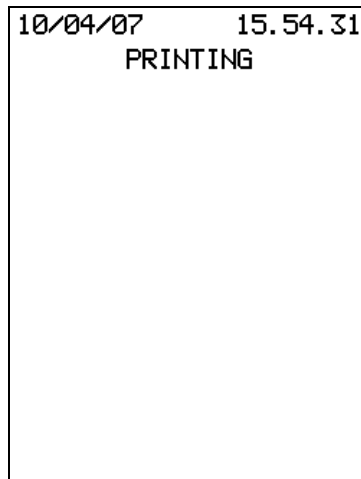

The sterilizer then changes to STAND BY mode.

To insert or replace a *printer 26* paper roll, simply open the *print door 18* and then the interior printer door. Both of these tilt downward. Insert or replace the paper roll with a compatible replacement (thermal paper) and thread one end through the upper slot. Press the FEED button on the printer to advance the paper through the slot in the door. Then close the door on the *printer 26* and the *door 18* of the control panel.

### Cycle Recording on SterilCard

If the sterilizer is equipped with a *SterilCard 06* (optional, standard on BHD models) and the Cycle Recording option has been enabled in the Main Settings Menu (see sec. 2.7), at the end of the cycle the information will be saved automatically to the *SterilCard 06* inserted.

The information on time, pressure, and temperature are saved each time the phase changes or after each minute in the cycle has passed, depending on the value of the Data logging parameter selected in the Main Settings Menu (see sec. 2.8).

If no *SterilCard 06* is inserted, at the end of the cycle the display will request one.

However, if a programmed and enabled *SterilCard 06* is inserted, the display will read "Cycle recording in progress".

If the operation concluded successfully, the sterilizer will display a message indicating that recording ended successfully. If there were errors, it will tell you that recording failed. In both cases, pressing one of the 4 multi-function buttons will return the sterilizer to STAND BY mode.

If the memory available on the *SterilCard 06* is nearly full, when you press START to begin a cycle, the display will show this message:

```
10/04/07    16.15.16
  MEMORY SPACE
  STERILCARD

      5
  CYCLES REMAINING
```

In this case, you are advised to transfer the files saved on the *SterilCard 06* to a PC. If the memory is entirely full, when you press START the screen will read:

```
10/04/07    16.20.09
  STERILCARD
  INSUFFICIENT MEMORY.

  TRANSFER CYCLES ON PC
    or
  DISABLE
  CYCLE RECORDING

  _____
  STAND BY
```

The saved data can be transferred to a computer with the CominoxReader kit (optional), which allows you to download and save the cycles and maintenance performed using dedicated software. Once the cycle and maintenance operations have been saved to a file on the computer, they can be deleted from the *SterilCard 06* to create space for the new cycles.

Otherwise, Cycle recording can be disabled in the Main Settings Menu (see sec. 2.7) and then the cycle can be run. However, in this case, information about the cycle will NOT be saved to the *SterilCard 06*, so another system must be enabled for saving the data (e.g. printer or CominoxWizard monitor program).

## INDICATORS

Indicators are messages containing notices or warnings that in most cases require a simple corrective action or check from the user.

The indicators are shown on the display with the corresponding icon and a brief description.

### Description / • Solution

Indicates that a scheduled maintenance procedure is needed for one or more components.

- contact a technical service center.

MAINTENANCE  
SCHEDULE

Indicates that a start has been programmed for the cycle on the display. The cycle will begin automatically at the date and time displayed.

PROGRAMMED  
START

Maximum level reached in *Clean water tank 10*.

MAX WATER  
LEVEL

Minimum level reached in *Clean water tank 10*.

- Fill the tank.

MIN WATER  
LEVEL

Activates when the *auto water fill 29* is set.

Indicates that the conductivity value of the water introduced has exceeded the optimum level but is still acceptable; the sterilizer allows a cycle to begin, but it is advisable to proceed according to instructions given for the WATER QUALITY INSUFFICIENT ALARM (see ALARMS).

CHECK WATER  
QUALITY

Indicates that the *waste water recovery tank 11* is full.

- Empty the tank (see MANUALLY DRAIN TANKS).

If the *direct drain 30* is installed (see CONNECTIONS), check the correct connection and that the pipe is not bent or clogged.

DRAIN WASTE  
WATER

Indicates that the temperature in the *chamber 09* is not suitable to start or continue a cycle.

COOLING  
PAUSE

Sterilizer preheating; the indicator notifies you that the external coil is operating.

PREHEATING

During the cycle, this indicates that the device that locks the *door 16* is active; it means that the door is closed and locked.

DOOR  
LOCKED

---

Activates at the end of a cycle or immediately after turning the sterilizer on, and indicates that the *door 16* release is underway. To access the *chamber 09*, wait until the indicator disappears, without attempting to open the door.

---

WAIT DOOR  
UNLOCK

Indicates that the cycle has completed and that the sterilizer is ready to begin a new cycle.

CYCLE  
COMPLETED

## ALARMS

The alarms indicate a need to conduct maintenance, or that some defect has been found.

If a defect is encountered during a cycle, the cycle is interrupted immediately, and a 15-second beep indicates an alarm. The description of the alarm appears on the display, including the cycle and phase in which it occurred. To reset the alarm, either enter the security code or insert the *SterilCard 06* and press SILENCE ALARM.

Once the alarm has been reset and the cause behind it has been resolved if possible, begin a new cycle. If the problem persists, contact an AUTHORIZED COMINOX TECHNICAL SERVICE CENTER.

The load in the sterilizer during an interrupted cycle should be considered NOT STERILE.

### Description / • Solution

Activates in STAND BY (see CHECK WATER QUALITY, Ch. INDICATORS). This indicates that the water conductivity value has exceeded the acceptable level.

- If a Cominox (Speedy Water or Osmosis) water demineralization system is installed, change the cartridge.
- If the water is filled from an external can, check that water.

INSUFF. WATER  
QUALITY ALARM

Indicates that distilled or demineralized water is lacking in the *clean water tank 10*.

- If the alarm is triggered at the beginning of a cycle, fill the tank (see MANUALLY FILL CLEAN WATER TANK, Ch. INSTALLATION).
- If the alarm is triggered during a cycle, fill the tank or follow the instructions provided for the INSUFFICIENT STEAM ALARM.

INSUFF. WATER LEVEL  
ALARM

Indicates that the necessary time was exceeded for the correct water level to be reset in the *chamber 09*.

- Recheck the tilt of the sterilizer (see Ch. INSTALLATION).

CHAMBER LEVEL  
ALARM

Indicates that there is a leak of steam or overheated steam in the *chamber 09*.

- Check the efficiency and cleanliness of the *door gasket 31* as well as the internal *door 16* disk the seal is fitted to. Replace if damaged (see CLEANING and CONTROLS in Ch. MAINTENANCE).
- Run a VACUUM test to check for pressure leaks.
- Recheck the tilt of the sterilizer (see Ch. INSTALLATION).
- Check that the total maximum load weight (see Table of cycles/sterilizable material) has not been exceeded.

INSUFFICIENT  
STEAM ALARM



Indicates that small steam leaks or an unsaturation of steam has prevented the correct rise in temperature in the *chamber 09* during the pressurization phase.

- Follow the instructions specified in the case of the INSUFFICIENT STEAM ALARM.
- If the alarm persists, this could be due to a problem in the electric heating circuit: contact a technical service center.

PRESSURIZATION  
ALARM

Indicates that the temperature inside the *chamber 09* has exceeded 150°C.

- If the alarm persists, contact a technical service center.

PT1 OVERTEMP.  
ALARM

Indicates that, during a vacuum peak in the vacuum pulse phase, the pressure failed to drop to the preset value.

- Follow the instructions specified in the case of the INSUFFICIENT VACUUM ALARM.
- Check that the total maximum load weight (see Table of cycles/sterilizable material) has not been exceeded.

FRAC. VACUUM  
ALARM

Indicates that during the pre-vacuum, the pressure failed to drop to the preset value.

- Check the efficiency and cleanliness of the *door gasket 31* as well as the internal *door 16* disk the seal is fitted to. Replace if damaged (see Ch. MAINTENANCE).
- Check that the *drain filter 20* is clean and positioned correctly (see Ch. MAINTENANCE).
- Run a VACUUM test to check for pressure leaks.
- Check that ventilation air vents are clear (see PREP. FOR BUILT-IN, Ch. INSTALLATION) and ask a technician to check the efficiency of the internal fan(s).

INSUFFICIENT VACUUM  
ALARM

STERILIZATION TEMPERATURE BAND: OVERTEMP.

Indicates that during sterilization the temperature or theoretical steam temperature has exceeded the maximum temperature anticipated for the sterilization temperature range.

- If the alarm persists, contact a technical service center to check the calibration of the temperature and pressure sensors.

STERIL. TEMP. BAND:  
OVERTEMP.

STERILIZATION TEMPERATURE BAND: UNDERTEMP.

Indicates that during sterilization, the temperature or theoretical temperature of the steam has dropped below the minimum value anticipated for the sterilization temperature range.

- Check that the total maximum load weight (see Table of cycles/sterilizable material) has not been exceeded.

STERIL. TEMP. BAND:  
UNDERTEMP.

Indicates a problem with the level probes.

- Empty and refill the *clean water tank 10* when the unit is off and idle.

LEVEL PROBES  
ALARM

Indicates that the *chamber 09* is overheated, and the *safety thermostat 17* has been triggered.

- Contact a technical service center.

COILS  
ALARM

Activates in STAND BY when the *auto water fill 29* is installed (see Ch. CONNECTIONS).

- If configuration A is set, the distilled or demineralized water tank must be refilled or replaced.
- If configuration B is set, check that the water main tap is open and that the mains pressure is compliant.

SELF-FILLING  
ALARM

Indicates that the *door 16* was not closed correctly.

- Close the door firmly before starting a cycle.

DOOR  
ALARM

This alarm triggers when the temperature sensor in the sterilizer is disconnected or broken.

- Contact a technical service center to check the temperature sensor.

TEMP. SENSOR PT1  
ALARM

Indicates that during draining, pressure did not drop to the correct preset value.

- Follow the instructions provided for the INSUFFICIENT VACUUM ALARM.
- Check that the total maximum load weight (see Table of cycles/sterilizable material) has not been exceeded.

DRAIN  
ALARM

Indicates that the temperature in the *chamber 09* does not correspond to the theoretical steam temperature.

- If the alarm persists, contact a technical service center to check the calibration of the temperature and pressure sensors.

MISALIGNMENT  
ALARM

This alarm triggers when the pressure sensor in the sterilizer is disconnected or broken.

- Contact a technical service center to check the pressure sensor.

PRESSURE TRANSD.  
ALARM

Indicates the while the cycle was underway, the STOP button was pressed before the natural completion of the cycle.

- Consider the load to be NOT STERILE and run a new sterilization cycle.

MANUAL STOP  
ALARM

Indicates that during a cycle, there was a drop in the power supply to the unit. When power is restored to the unit, the display will show a message about the phase in which power dropped.

Whenever there is a power cut while an alarm is active, the display will show the last alarm triggered.

POWER MISSING  
ALARM

Indicates that a time-controlled phase (sterilization, drying or maintenance in the Vacuum Test) was not correctly completed.

- Contact a technical service center.

EVENTS  
ALARM

- Check the power supply at the plug, and that the *power cord 03* is inserted correctly in the plug and in its connection in the sterilizer.
- Check the *fuses 32* and that the *main switch 13* is pressed to the "I" position.

NO MESSAGE IS  
SHOWN ON THE  
DISPLAY

- Check the efficiency and cleanliness of the *door gasket 31* as well as the *door 16* disk the seal is fitted to. Replace if damaged (see Ch. MAINTENANCE).
- Contact a technical service center to have the *door 16* closure adjusted.

STEAM LOSS  
FROM THE DOOR

At the end of the cycle, there is still water in the *chamber 09*.

- Check that the *drain filter 20* is clean and positioned correctly (see Ch. MAINTENANCE).
- Recheck the tilt of the sterilizer (see Ch. INSTALLATION).

WATER IN THE  
CHAMBER AFTER  
THE CYCLE

Drying after the cycle is not satisfactory.

- Check that the cycle selected is appropriate for the material to be sterilized (see Table of cycles/sterilizable material).
- Check that the total maximum load weight has not been exceeded (see Table of cycles/sterilizable material).
- Check that the load was correctly prepared.
- Check the *air sterilization filter 15* and replace if needed (see Ch. MAINTENANCE).
- Follow the instructions provided for the previous problem.

DRYING  
UNSATISFACTORY

At the end of the cycle, pressure rises very slowly.

- Check the *air sterilization filter 15* and replace if needed (see Ch. MAINTENANCE).

PRESSURE  
INCREASES SLOWLY

The *printer 26* (optional) does not print.

- Check that the printer has been enabled in the Main Settings Menu (see Ch. OPERATION).

PRINTER  
DOES NOT PRINT

If the *printer 26* is installed and enabled, but the printout is not available at the end of the cycle, check that the paper roll is positioned correctly and that the printer door is properly closed. If the printer is out of paper or the door is open, the ERROR light will flash on the printer.

- Consult the PRINTER chapter and follow the instructions provided.

If the POWER light on the *printer 26* is off, the printer is not correctly powered:

- contact a qualified technical service center.
- 

The *auto water fill 29* (optional, standard on BHD models) isn't working.

- Check that the Self-filling option is set to ON in the Main Settings Menu (see Ch. OPERATION).
- If configuration A with external can is installed and enabled, check whether there is water in the can. If there is water and the SELF-FILLING ALARM is active, check that the extraction tube is properly positioned so that it touches the bottom of the can. Check that the tube is not kinked or twisted. Check that the height difference between the sterilizer and the bottom of the can is not more than 1 meter (see CONNECTIONS, Ch. INSTALLATION).
- If configuration B from the water mains is installed and enabled, check that the water mains tap is open. If the tap is open and the SELF-FILLING ALARM is active, check that water is flowing downstream from the Cominox demineralization system.
- If none of the solutions provided here solves the problem, contact a technical service center, and in the meantime disable the Self-Filling setting (see Ch. OPERATION) and use MANUAL CLEAN WATER REFILL (see Ch. INSTALLATION) to continue using the sterilizer.

AUTOMATIC WATER  
FILL DOES NOT WORK

Steam loss from the *safety valve 12*.

- If the sterilizer is installed at more than 1500 meters above sea level, contact a technical service centre to have a suitable safety valve installed (see Ch. TECHNICAL SPECIFICATIONS).
  - If the altitude is below 1500 meters asl but the problem persists, contact a technical service center to check the efficiency of the valve.
- 

STEAM LOSS  
FROM THE SAFETY  
VALVE

---

**List of alarm codes**

<b>Code</b>	<b>Type of alarm</b>
00	COILS ALARM
01	PT1 OVERTEMPERATURE ALARM
02	
03	INSUFFICIENT STEAM ALARM
04	INSUFF. WATER LEVEL ALARM
05	
06	MAX WATER LEVEL ALARM
07	DOOR ALARM
08	CHAMBER LEVEL ALARM
09	MANUAL STOP ALARM
10	INSUFFICIENT VACUUM ALARM
11	FRAC. VACUUM ALARM
12	
13	PROBE LEVEL ALARM
14	PRESSURIZATION ALARM
15	OVERTEMP. BAND ALARM
16	UNDERTEMP. BAND ALARM
17	
18	POWER MISSING ALARM
19	
20	
21	DRAIN ALARM
22	MISALIGNMENT ALARM
23	PRESSURE TRANSD. ALARM
24	TEMP. SENSOR PT1 ALARM
25	
26	
27	
28	
29	
30	EVENTS ALARM

## MAINTENANCE

### GENERAL CONDITIONS



*All maintenance must be performed by qualified and trained technical personnel only.*

**Maintenance must be performed when the unit is idle and unplugged from the power source unless otherwise specified.**



*Wait until the sterilizer has cooled completely and has NO heated surfaces. In any case proceed with caution.*

Avoid any temporary repairs; repairs must exclusively use original replacement parts.



*Always use personal means of protection.*

The operator must provide prompt notice of any problem: dripping, wear, fraying, etc.



*DO NOT allow the unit to be used if a problem of any kind has been detected, and arrange for proper restoration of normal operating conditions or make sure that steps are taken in this regard.*

**COMINOX** declines all responsibility if the maintenance plan indicated in this manual is not followed (see Maintenance Schedule table). Cominox also declines all responsibility if maintenance is entrusted to untrained personnel or if the procedures suggested by our installation technicians are not respected.



*For any defect or problem that cannot be resolved using this manual, contact a COMINOX TECHNICAL SERVICE CENTER. Please contact COMINOX for further details about the nearest TECHNICAL SERVICE CENTER.*

### Cleaning

Clean the sterilization *chamber 09* and the internal disk on the *door 16 each day*. Use a cotton cloth soaked in alcohol or distilled water.

During cleaning, it is advisable to wear protective gloves.

If any scale is found, use stainless steel polishing products. Then remove any product residue with a degreasing product and rinse thoroughly with distilled water.



*NEVER use chlorine-based detergents (bleach) which could lead to oxidation in the sterilization chamber. DO NOT use abrasive sponges or wools.*

Clean the workplace **every day**, checking that there are no clogs or blockages to prevent proper ventilation of the sterilizer.

Clean the *clean water tank 10* and the *waste water recovery tank 11*. Empty them completely at least every six months and refill the clean water tank with clean water (see Water supply table).

If the sterilizer will not be used for a long period, leave the tanks empty.

### Filters

Replace the *air sterilization filter 15* at least **every six months**: remove the filter and screw in the new one.

**Annually** check the efficiency of the *waste filter 20* as follows:

- open the *door 16*.
- remove the filter by pulling upward.
- check it, and clean with a jet of compressed air or replace it.
- replace the filter.

### Checks

At least **once a month** check the efficiency of the *door gasket 31* and replace it if there is damage.

To extend the life of the filter, it is best to leave the *door 16* ajar, but not locked with the handle, when the unit is not being used.

**Every day**, check that there are no drips or seepage in the work area, since they can cause a slipping danger.



*At least **annually**, check the calibration of the pressure and temperature probes. The probes check must be performed strictly by specialized personnel or at a **COMINOX TECHNICAL SERVICE CENTER***

### Fuses

To calibrate the *fuses 32*, refer to the label plate inside the *door 18*.

## STORAGE AND DISPOSAL

### Sterilizer storage or long-term disuse



*If the sterilizer will NOT be used immediately, or if it will be stored for long periods, check that it is packaged correctly.*

The sterilizer must be stored only in closed but well-ventilated locations that have no special characteristics that might be harmful to the sterilizer components, especially electronic components.

If necessary, cover the unit with cellophane and use desiccant salts.

DO NOT place other loads different from machines of the same type on top of the packaging, and in any case do not stack more than 4 crates.

In any event, **after long periods of disuse**, the sterilizer will require checks and tests that cannot be fully described here. Ask **COMINOX** or an AUTHORIZED TECHNICAL SERVICE CENTER for more information.

When the unit will not be used for a long time, empty the tanks completely.

### Disposal and scrapping



*Should the sterilizer be dismantled, comply with the regulations in force in each individual country for the disposal of the various parts. In any event, avoid creating any sort of pollution.*

N.B. **COMINOX** declines all responsibility for damage to the environment or for systems used in the disposal of the materials that comprise the sterilizer or that are used in its operation.



*Dispose of the various types of materials used in the sterilizer in landfills that are suitable for each material.*



## Maintenance schedule table

Item	# of cycles or maximum time permitted	Date of operation	# of cycles at the time of the operation	Technician's signature
Air Filter	400 1 year			
Water Filter	1500 2 years			
Vacuum pump kit	1000 2 years			
SV2 drain	1500 2 years			
SV6 by-pass	3000 3 years			
Drain tank probe	1500 2 years			
Water fill pump	2000 2 years			
Internal coil	6000 6 years			
Door gasket	3000 2 years			
Chamber level probe	3000 3 years			
Fan/s	4000 3 years			
Temperature sensor 1	6000 6 years			
Chamber safety thermostat	6000 6 years			
Pressure Transducer	6000 6 years			
Chamber safety valve	6000 6 years			

APPENDIX 1: GRAPHICS 18 B – 18 BHD / 24B – 24 BHD

121 UNWRAPPED

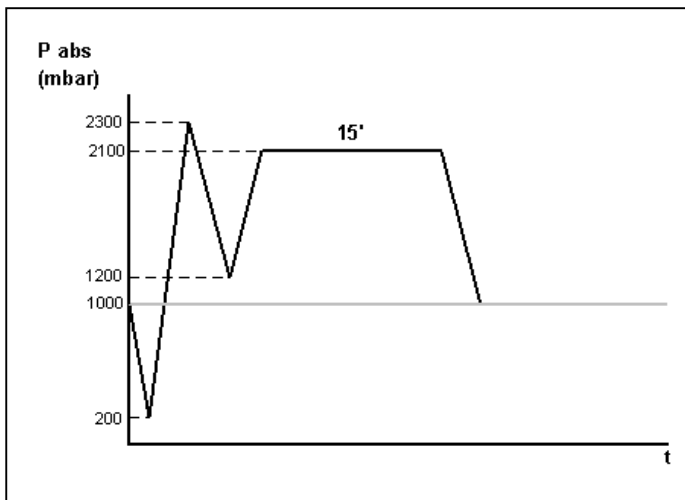

134 UNWRAPPED

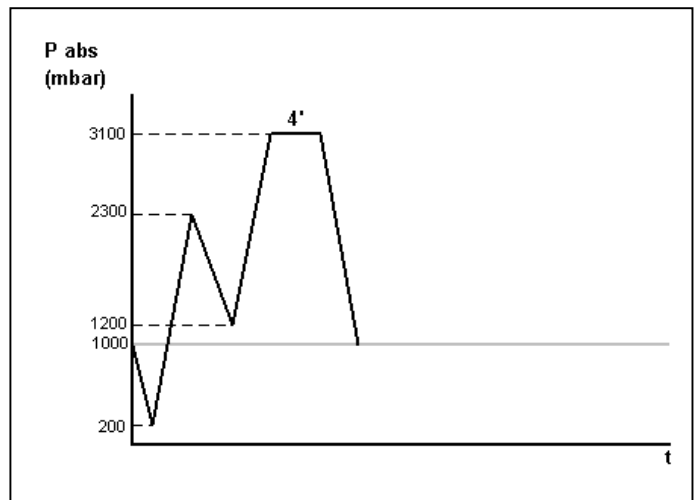

121 HOLLOW/POROUS

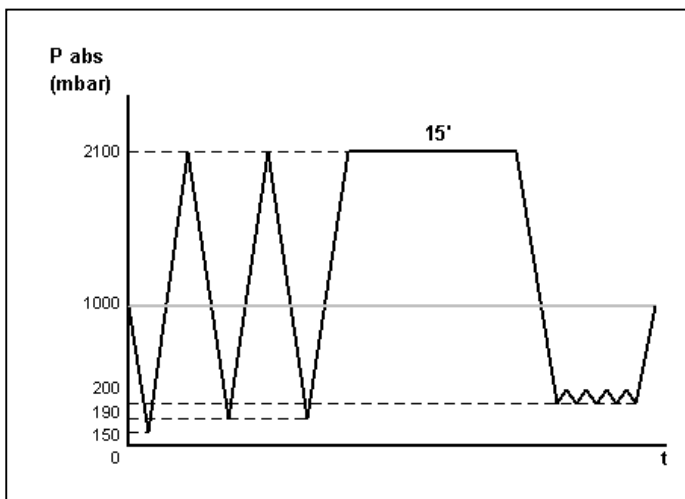

134 HOLLOW/POROUS

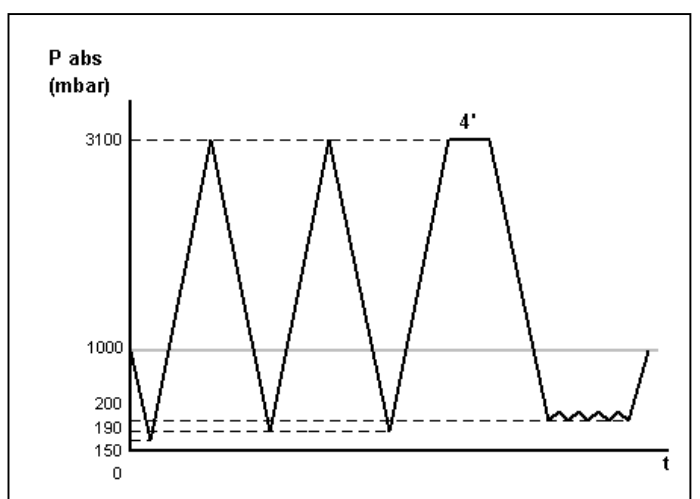

134 PRION

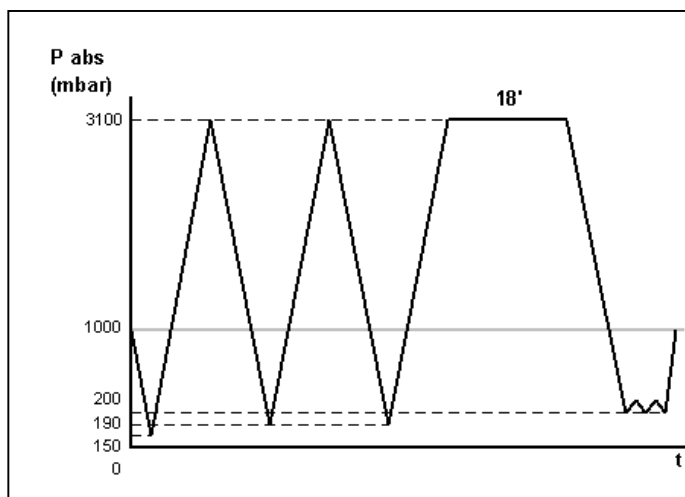

134 WRAPPED

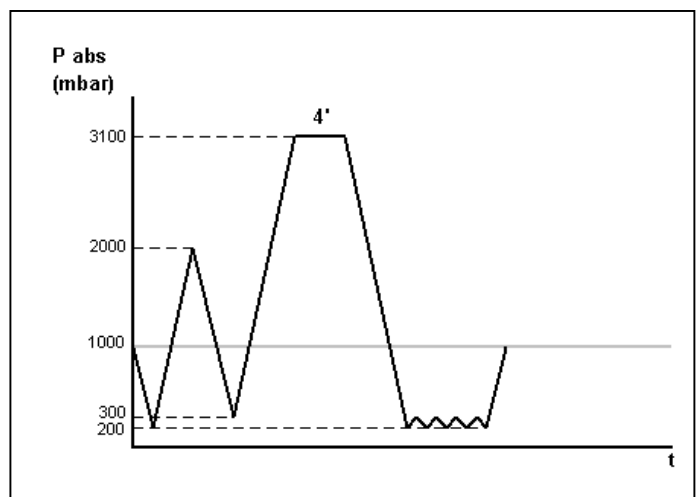

## APPENDIX 2: GRAPHICS 18 S

121 UNWRAPPED

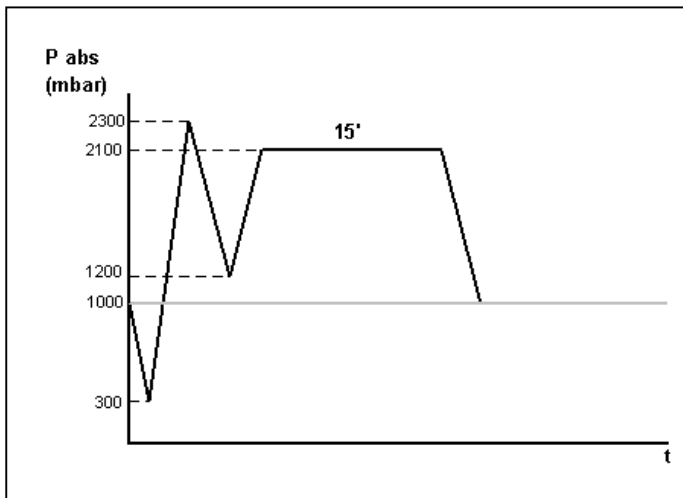

134 UNWRAPPED

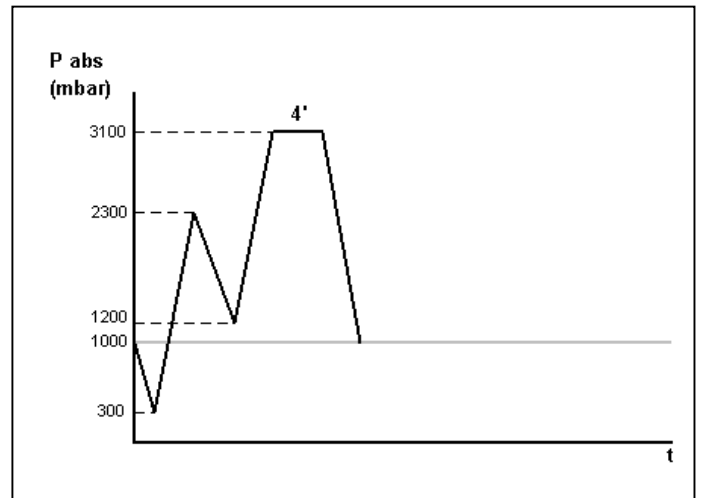

121 HOLLOW/POROUS

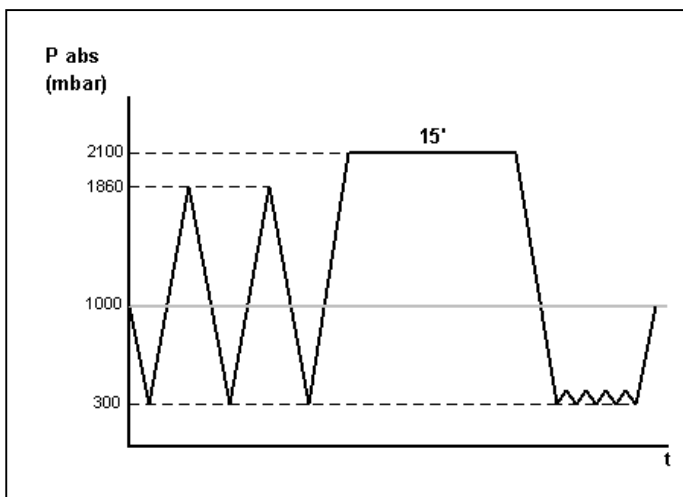

134 HOLLOW/POROUS

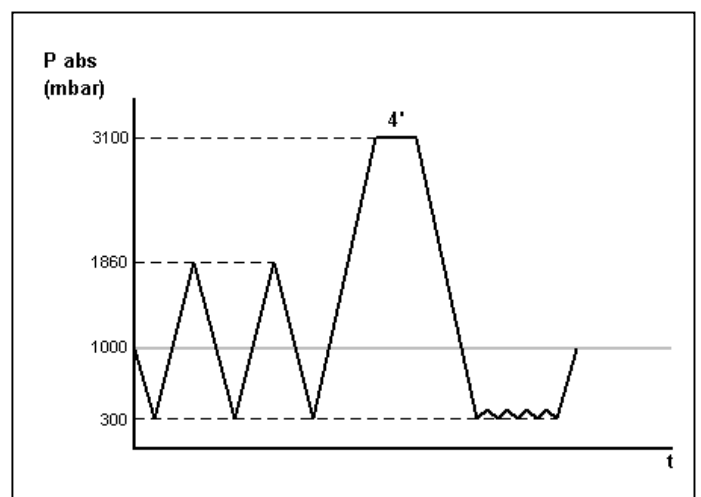

134 PRION

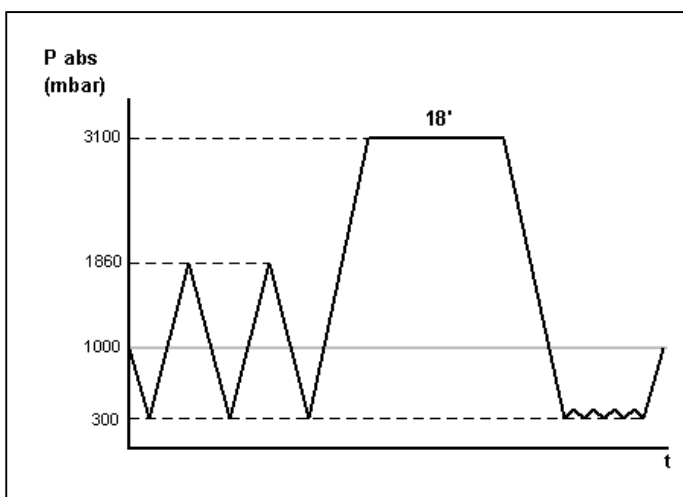

134 WRAPPED

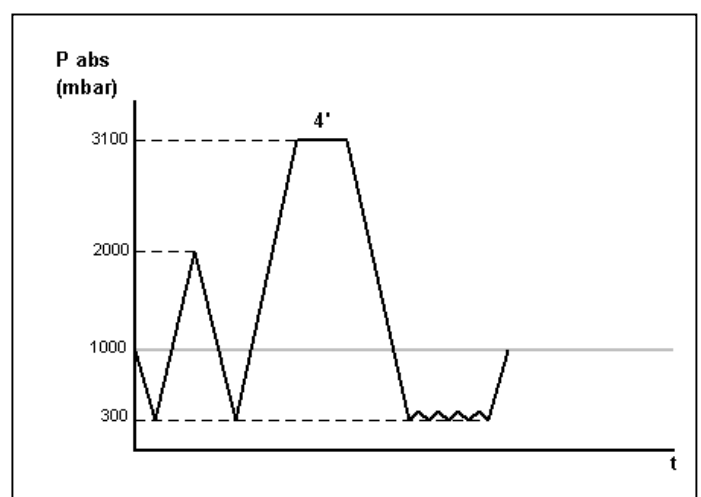



**COMINOX®**

**Cominox S.r.l.**

via G. Viganò, 7 - 20048 Carate B.za (Mi) Italia  
tel. +39 0362 912312 - Fax +39 0362 900940  
[www.cominox.it](http://www.cominox.it)